

IGBT MODULE

1200V / 15A / PIM

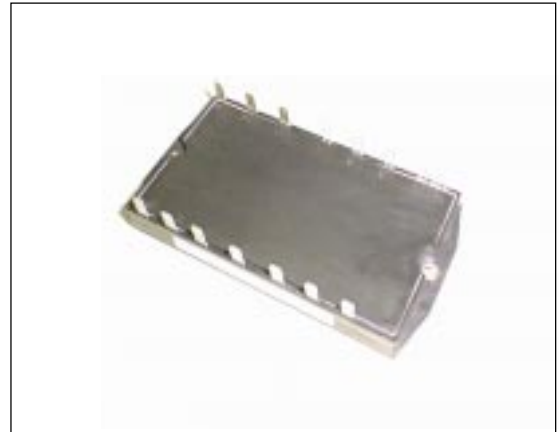

■ Features

- High Speed Switching
- Voltage Drive
- Low Inductance Module Structure
- Converter Diode Bridge Dynamic Brake Circuit

■ Applications

- Inverter for Motoe Drive
- AC and DC Servo Drive Amplifier
- Uninterruptible Power Supply

■ Maximum ratings and characteristics

● Absolute maximum ratings (Tc=25°C unless without specified)

Item	Symbol	Condition	Rating	Unit	
Inverter	Collector-Emitter voltage	V _{CEs}	1200	V	
	Gate-Emitter voltage	V _{GEs}	±20	V	
	Collector current	I _C	Continuous	15	A
		I _{CP}	1ms	30	A
		-I _C		15	A
Collector power dissipation	P _C	1 device	120	W	
Brake	Collector-Emitter voltage	V _{CEs}	1200	V	
	Gate-Emitter voltage	V _{GEs}	±20	V	
	Collector current	I _C	Continuous	10	A
		I _{CP}	1ms	20	A
		P _C	1 device	88	W
	Repetitive peak reverse voltage	V _{RRM}		1200	V
	Average forward current	I _{F(AV)}		1	A
Surge current	I _{FSM}	10ms	50	A	
Converter	Repetitive peak reverse voltage	V _{RRM}	1600	V	
	Non-Repetitive peak reverse voltage	V _{RSM}	1700	V	
	Average output current	I _O	50Hz/60Hz sine wave	25	A
	Surge current (Non-Repetitive)	I _{FSM}	T _J =150°C, 10ms	320	A
	I ² t (Non-Repetitive)		T _J =150°C, 10ms	512	A ² s
Operating junction temperature	T _J		+150	°C	
Storage temperature	T _{stg}		-40 to +125	°C	
Isolation voltage	V _{iso}	AC : 1 minute	AC 2500	V	
Mounting screw torque			1.7 * ₁	N·m	

*₁ Recommendable value : 1.3 to 1.7 N·m (M4)

● Electrical characteristics (Tj=25°C unless without specified)

Item	Symbol	Condition	Characteristics			Unit	
			Min.	Typ.	Max.		
Inverter (IGBT)	Zero gate voltage collector current	ICES	VCE=1200V, VGE=0V			1.0	mA
	Gate-Emitter leakage current	IGES	VCE=0V, VGE=±20V			20	µA
	Gate-Emitter threshold voltage	VGE(th)	VCE=20V, IC=15mA			4.5	V
	Collector-Emitter saturation voltage	VCE(sat)	VGE=15V, IC=15A			3.3	V
	Collector-Emitter voltage	-VCE	-IC=15A			3.0	V
	Input capacitance	Cies	VGE=0V, VCE=10V, f=1MHz			2400	pF
	Switching time	ton	VCC=600V			1.2	µs
		tr	IC=15A			0.6	µs
		toff	VGE=±15V			1.5	µs
		tf	RG=82 ohm			0.5	µs
Reverse recovery time of FRD	trr	IF=15A			0.35	µs	
Brake (IGBT)	Zero gate voltage collector current	ICES	VCE=1200V, VGE=0V			1.0	mA
	Gate-Emitter leakage current	IGES	VCE=0V, VGE=±20V			0.1	µA
	Collector-Emitter saturation voltage	VCE(sat)	IC=10A, VGE=15V			3.3	V
	Switching time	ton	VCC=600V			0.8	µs
		tr	IC=10A			0.6	µs
		toff	VGE=±15V			1.5	µs
tf		RG=120 ohm			0.5	µs	
Brake (FWD)	Reverse current	IRRM	VR=1200V			1	mA
	Reverse recovery time	trr				0.6	µs
Converter	Forward voltage	VFM	IF=25A			1.4	V
	Reverse current	IRRM	VR=1600V			1.0	mA

● Thermal Characteristics

Item	Symbol	Condition	Characteristics			Unit
			Min.	Typ.	Max.	
Thermal resistance (1 device)	Rth(j-c)	Inverter IGBT			1.04	°C/W
		Inverter FRD			2.78	
		Brake IGBT			1.43	
		Converter Diode			3.40	
Contact thermal resistance *	Rth(c-f)	With thermal compound		0.05		

* This is the value which is defined mounting on the additional cooling fin with thermal compound

■ Equivalent Circuit Schematic

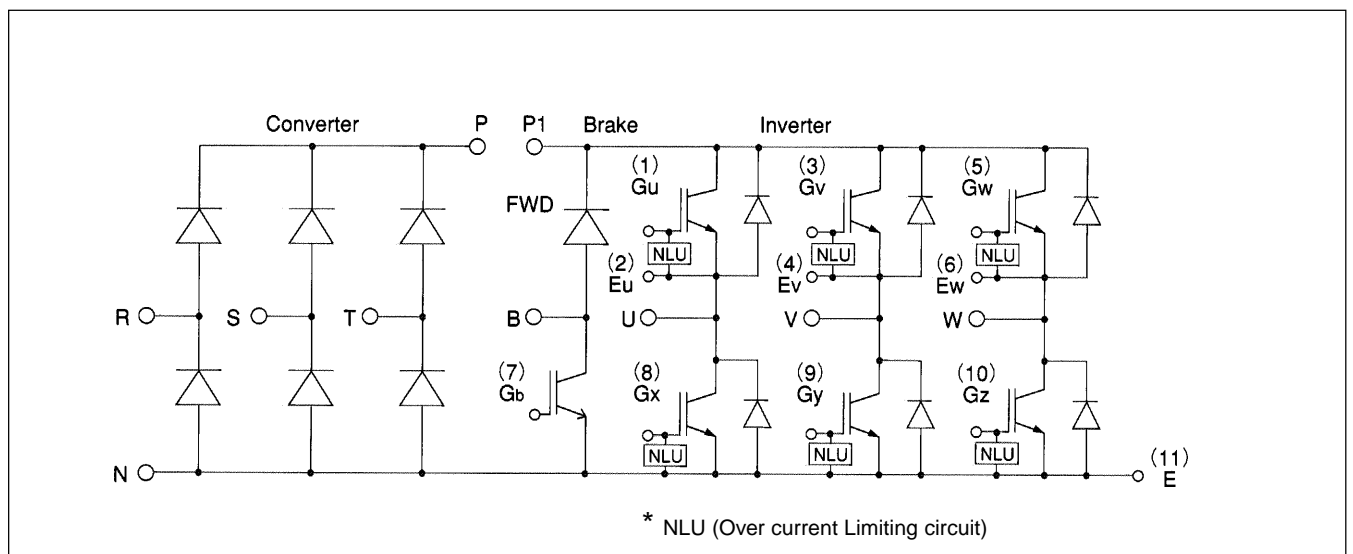

■ Characteristics (Representative)

● Inverter

Collector current vs. Collector-Emitter voltage
T_j=25°C

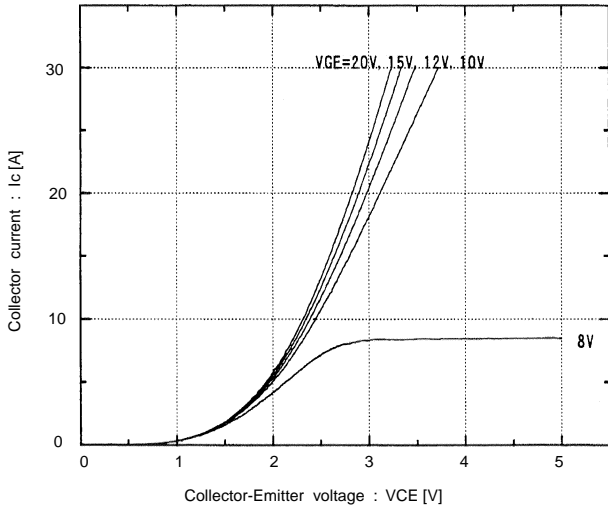

Collector current vs. Collector-Emitter voltage
T_j=125°C

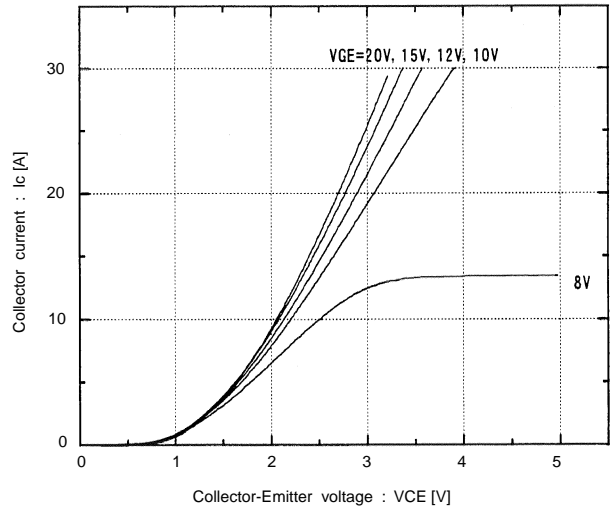

Collector-Emitter vs. Gate-Emitter voltage
T_j=25°C

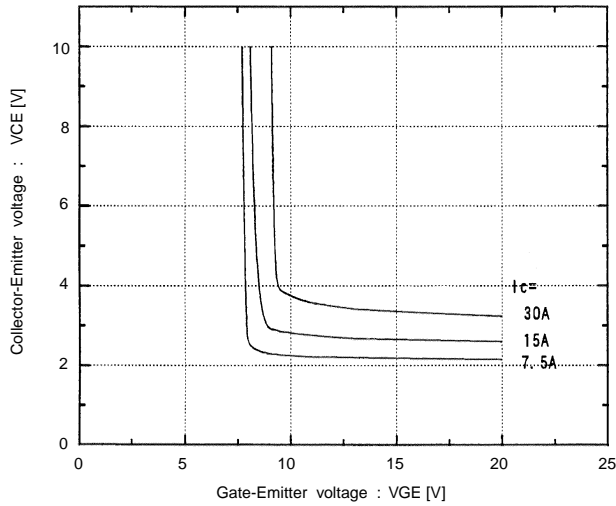

Collector-Emitter vs. Gate-Emitter voltage
T_j=125°C

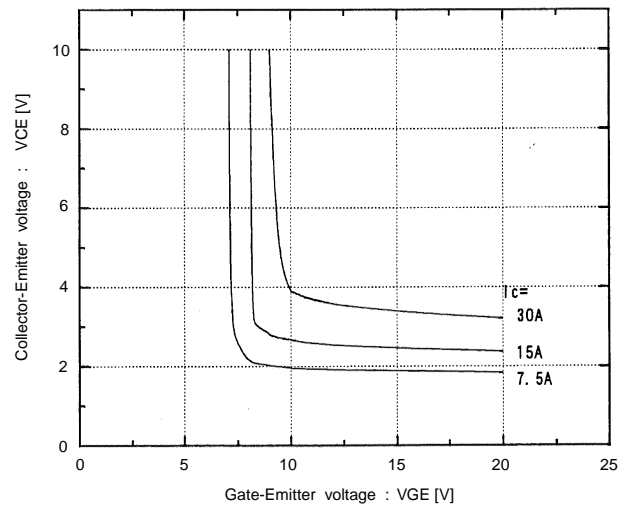

Switching time vs. Collector current
V_{cc}=600V, R_G=82 ohm, V_{GE}=±15V, T_j=25°C

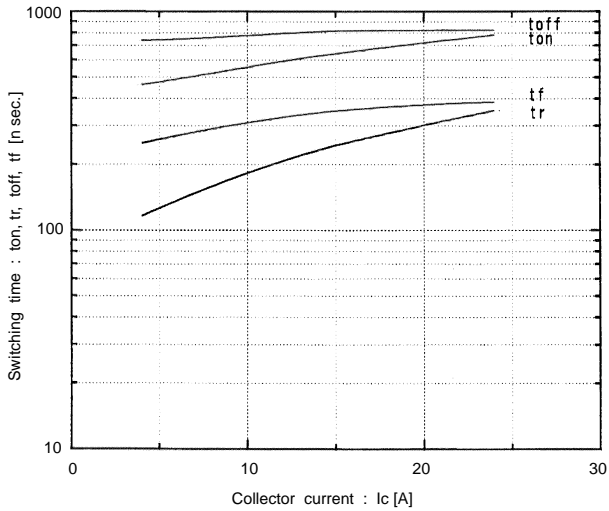

Switching time vs. Collector current
V_{cc}=600V, R_G=82 ohm, V_{GE}=±15V, T_j=125°C

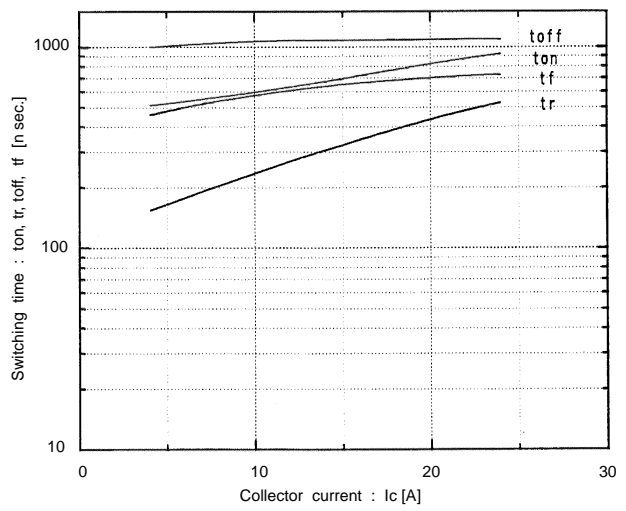

Switching time vs. RG
 $V_{cc}=600V, I_c=15A, V_{GE}=\pm 15V, T_j=25^\circ C$

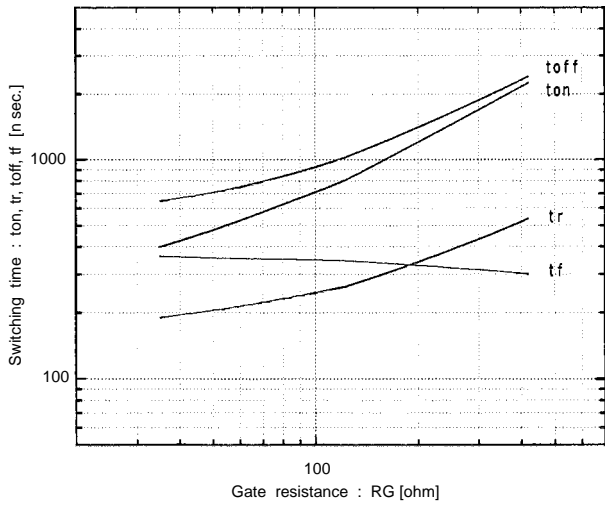

Dynamic input characteristics
 $T_j=25^\circ C$

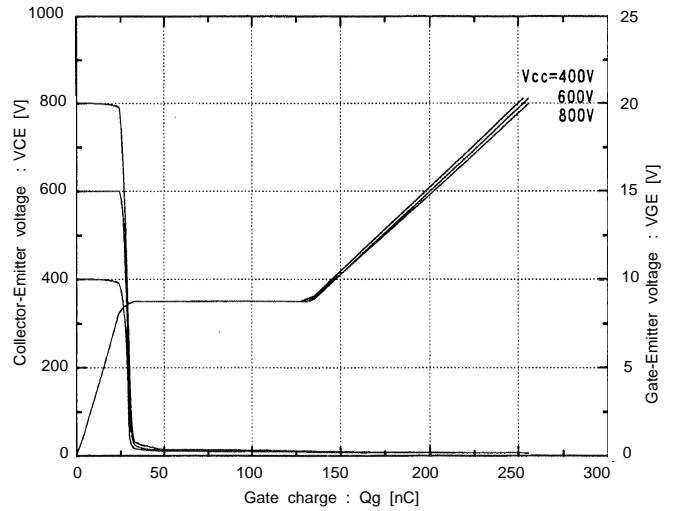

Forward current vs. Forward voltage
 $V_{GE}=0V$

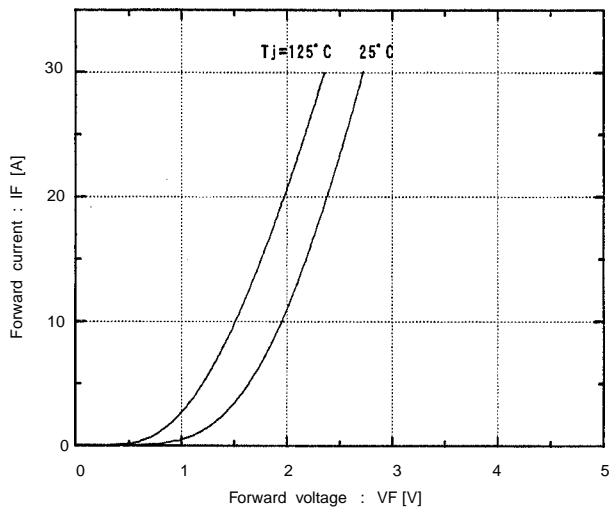

Reverse recovery characteristics
 t_{rr}, I_{rr} , vs. I_F

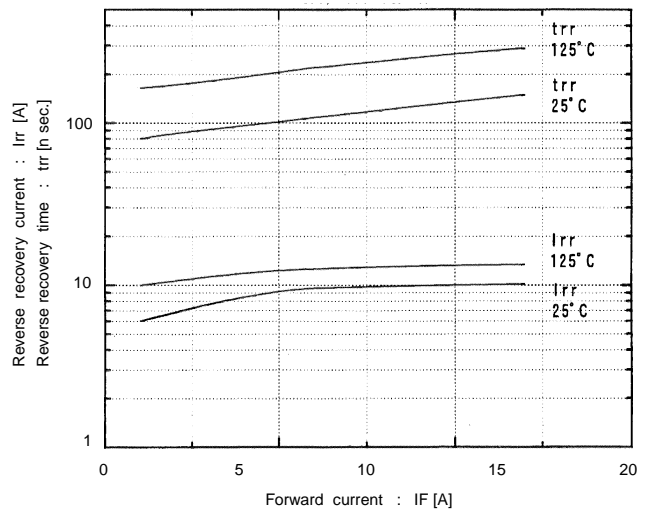

Transient thermal resistance

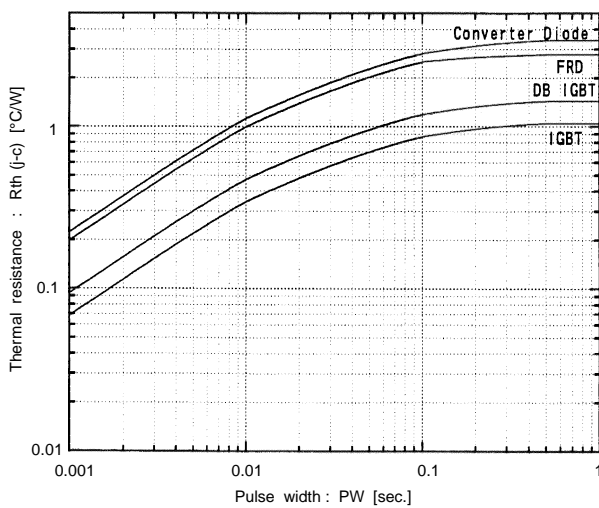

Reversed biased safe operating area
 $+V_{GE}=15V, -V_{GE} \leq 15V, T_j \leq 125^\circ C, R_G \geq 82 \text{ ohm}$

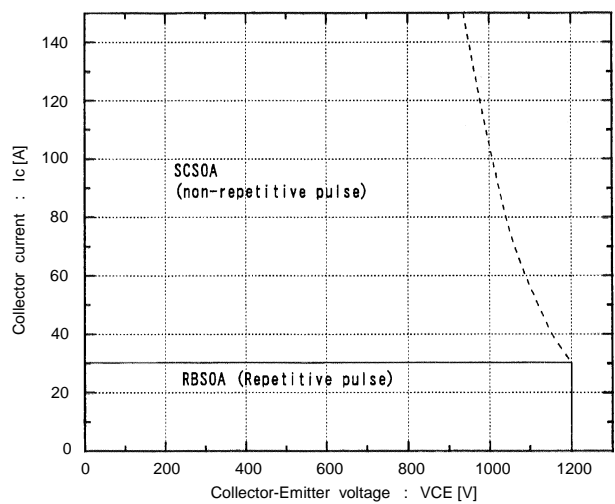

Switching loss vs. Collector current
 $V_{cc}=600V$, $R_G=82\text{ ohm}$, $V_{GE}=\pm 15V$

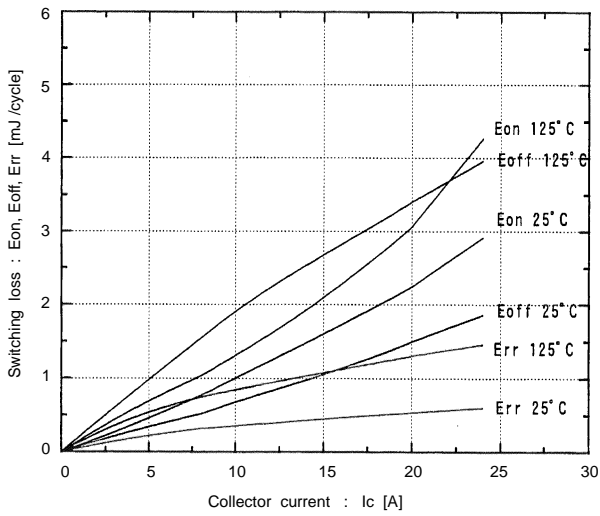

Capacitance vs. Collector-Emitter voltage
 $T_j=25^\circ\text{C}$

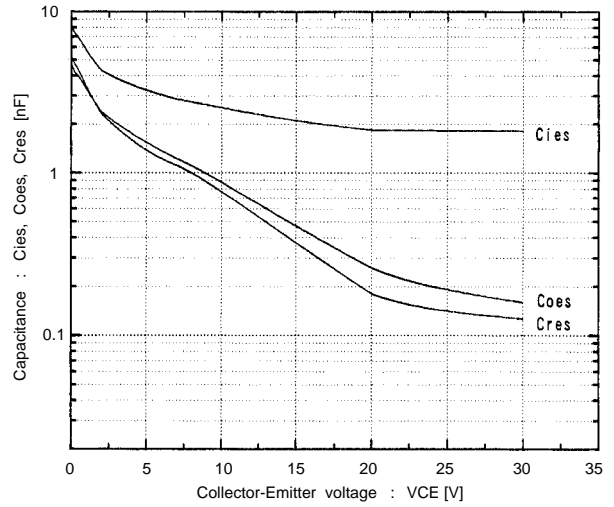

Converter Diode
 Forward current vs. Forward voltage

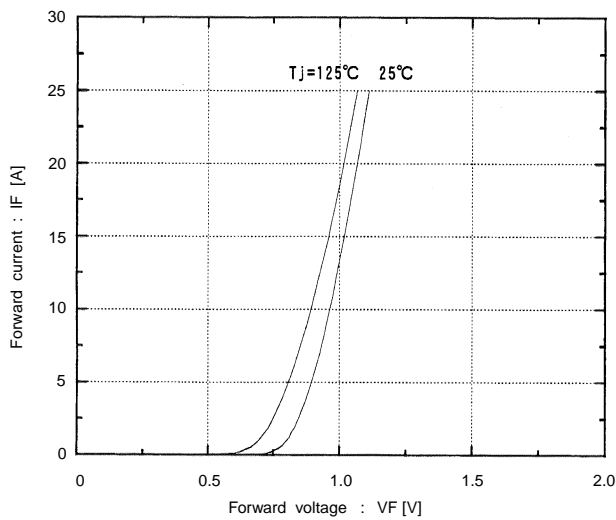

● Brake

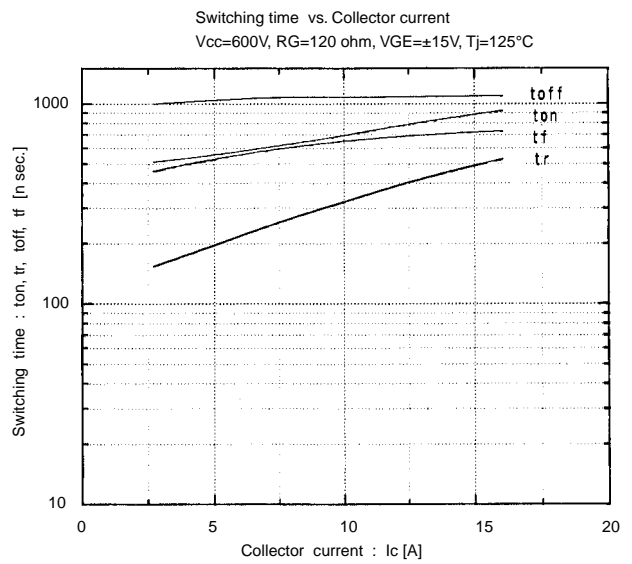
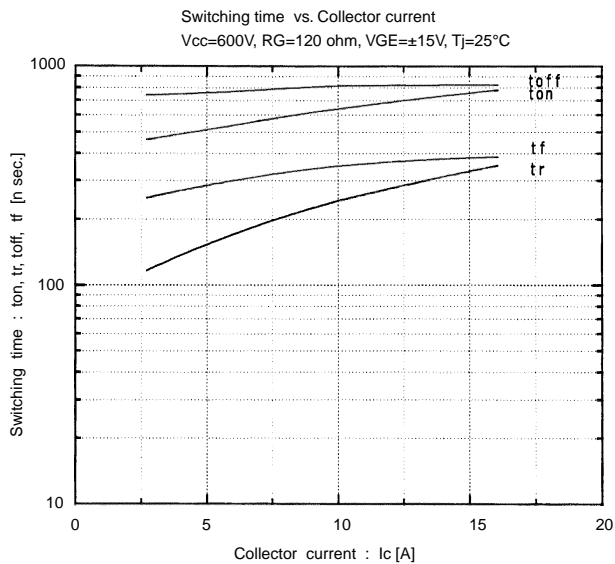
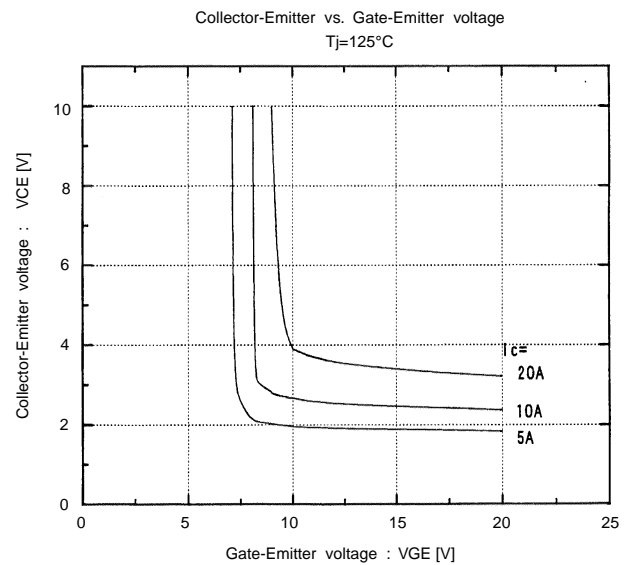
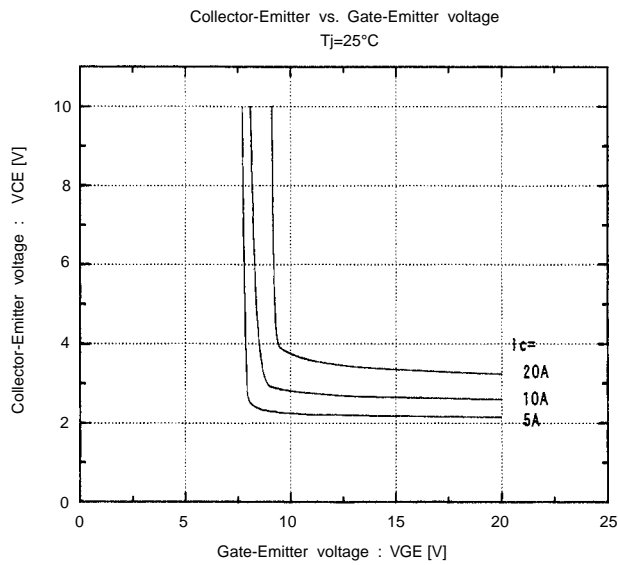
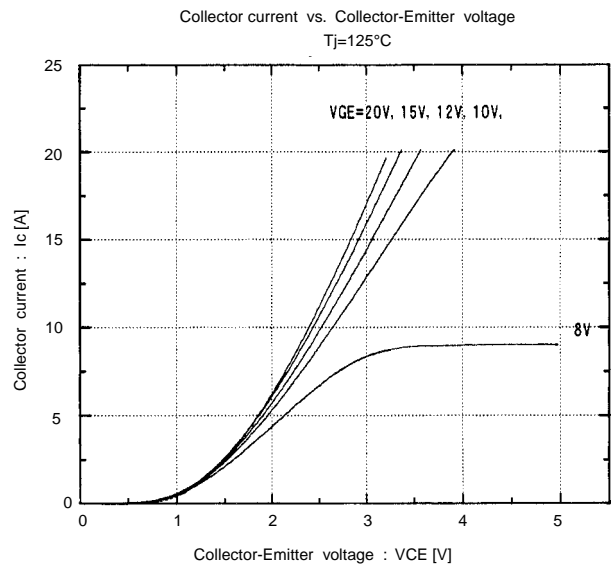
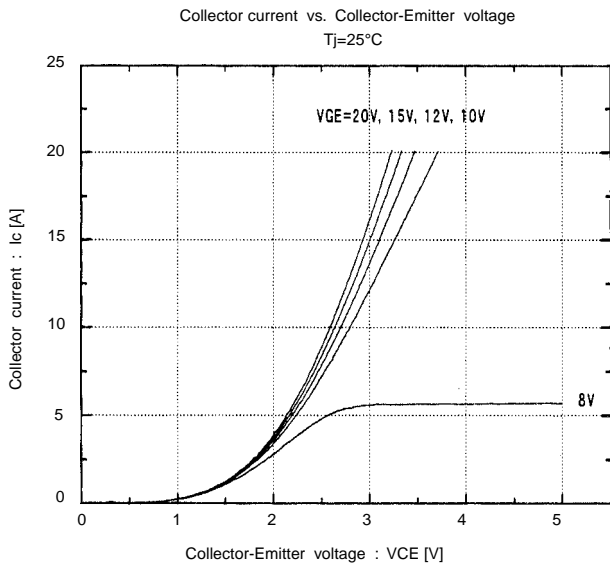

Switching time vs. RG
 Vcc=600V, Ic=10A, VGE=±15V, Tj=25°C

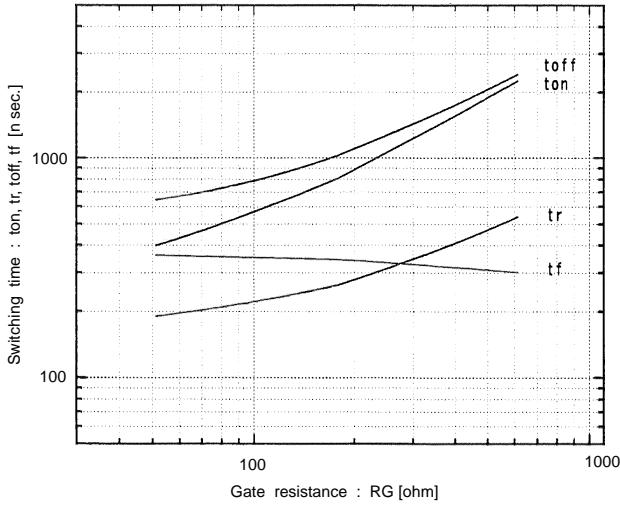

Dynamic input characteristics
 Tj=25°C

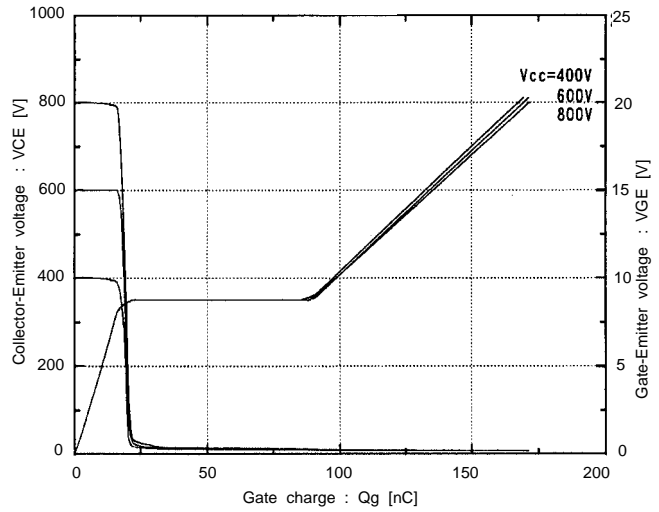

Reversed biased safe operating area
 +VGE=15V, -VGE ≤ 15V, Tj ≤ 125°C, RG ≥ 120 ohm

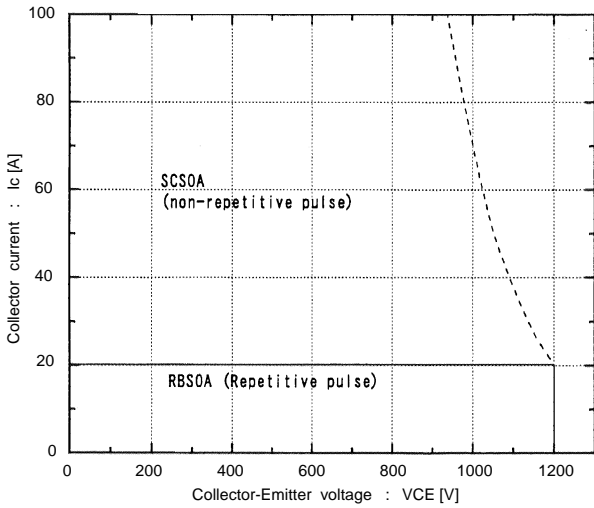

Switching loss vs. Collector current
 Vcc=600V, RG=120 ohm, VGE=±15V

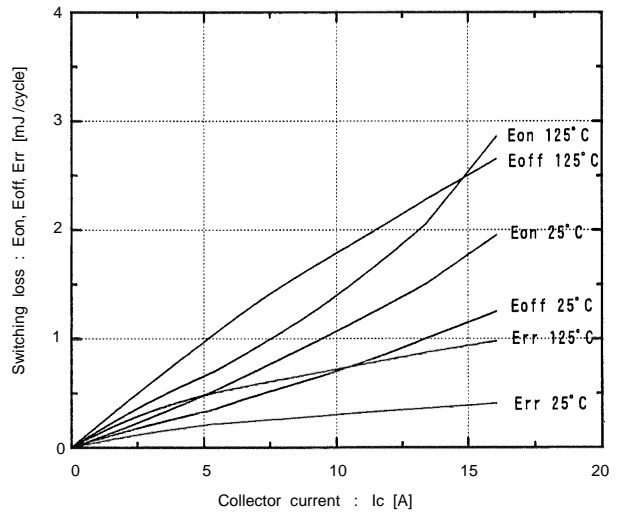

Capacitance vs. Collector-Emmitter voltage
 Tj=25°C

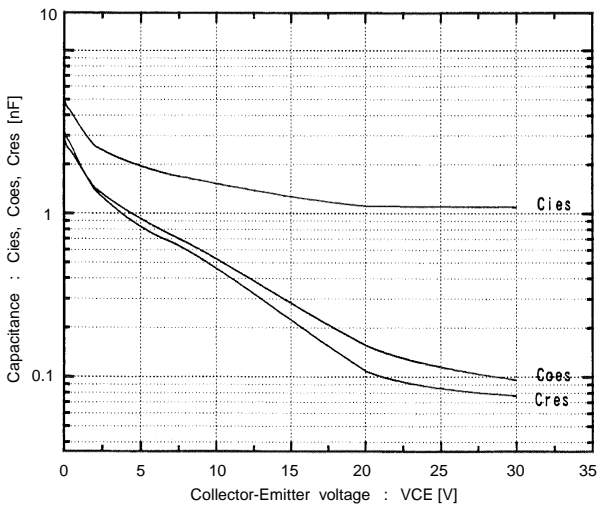

■ Outline Drawings, mm

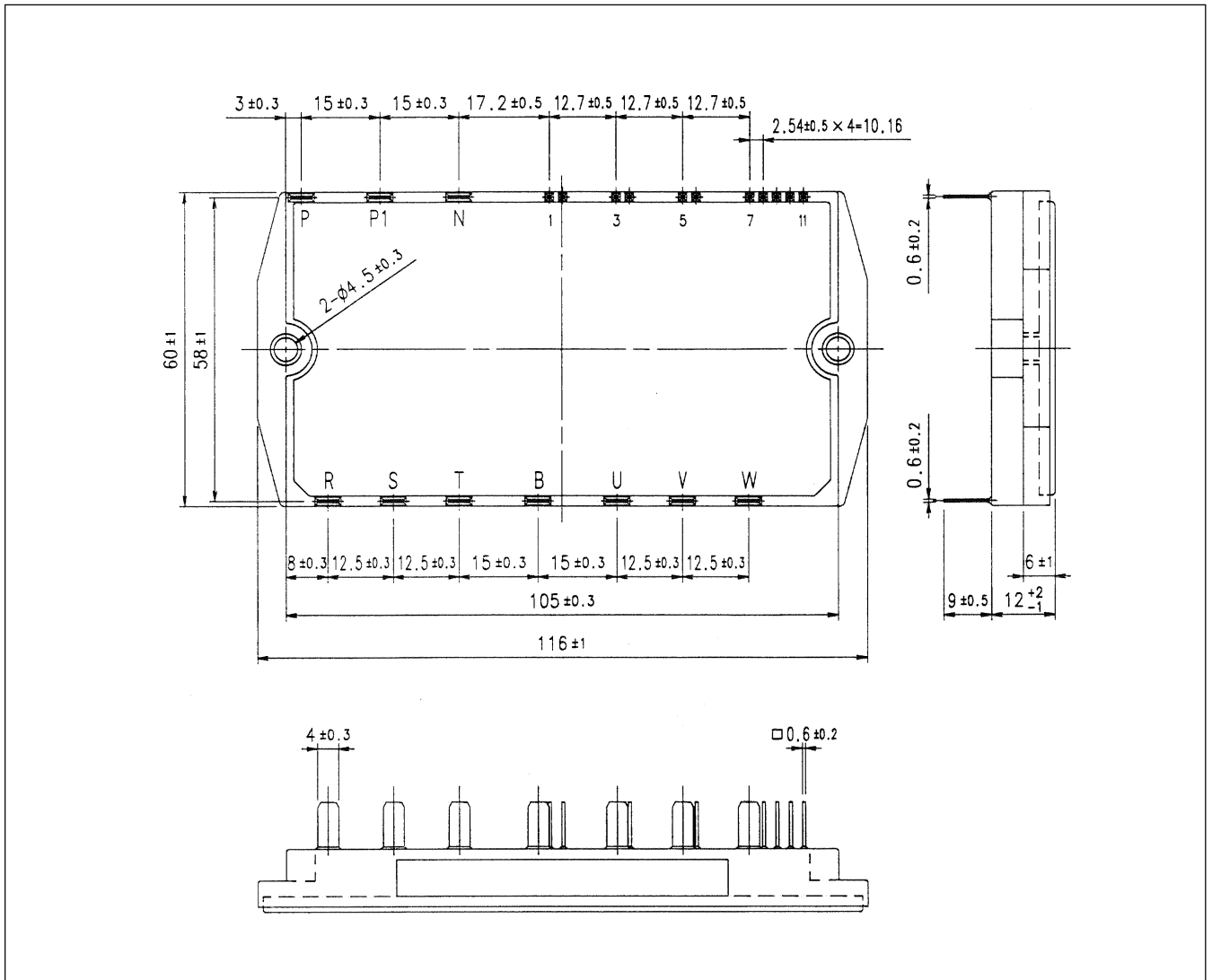

For more information, contact:

Collmer Semiconductor, Inc.

P.O. Box 702708

Dallas, TX 75370

972-733-1700

972-381-9991 Fax

<http://www.collmer.com>