

CM50TU-24F

HIGH POWER SWITCHING USE

CM50TU-24F



- Ic 50A
- VCES 1200V
- Insulated Type
- 6-elements in a pack

APPLICATION

General purpose inverters & Servo controls, etc

OUTLINE DRAWING & CIRCUIT DIAGRAM

Dimensions in mm

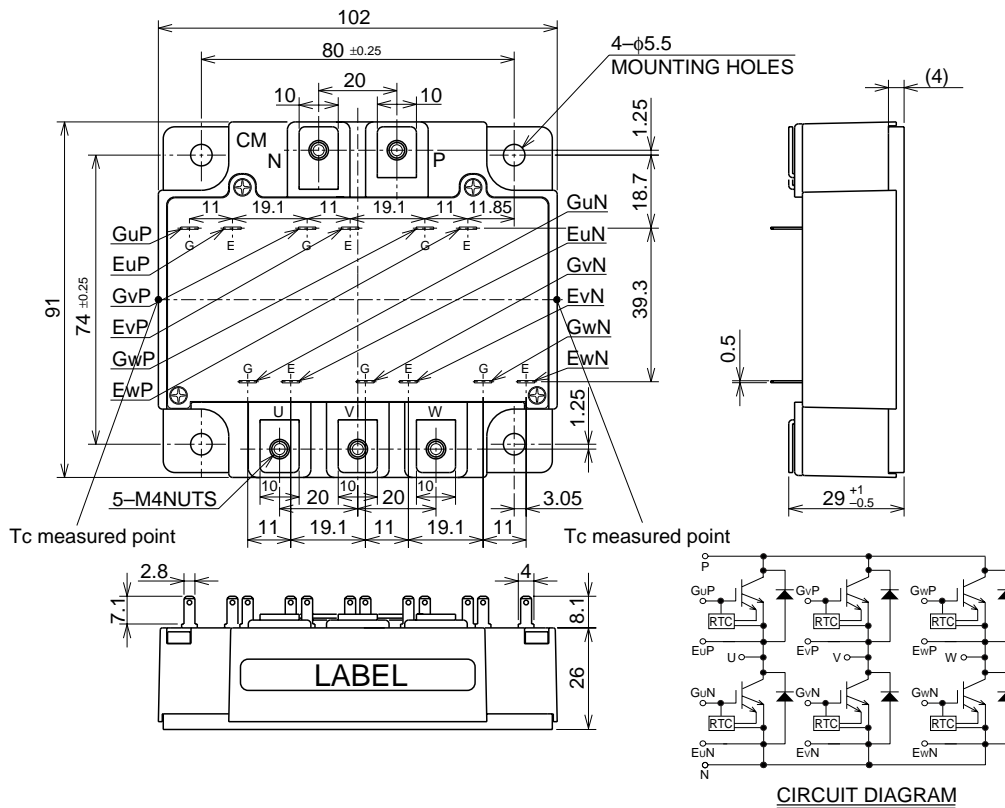

CM50TU-24F

HIGH POWER SWITCHING USE

MAXIMUM RATINGS (Tj = 25°C)

| Symbol | Parameter | Conditions | Ratings | Unit |
|--------------------------|-------------------------------|--|------------|-------|
| V _{CE} S | Collector-emitter voltage | G-E Short | 1200 | V |
| V _{GE} S | Gate-emitter voltage | C-E Short | ±20 | V |
| I _C | Collector current | T _C = 25°C | 50 | A |
| I _{CM} | | Pulse (Note 2) | 100 | |
| I _E (Note 1) | Emitter current | T _C = 25°C | 50 | A |
| I _{EM} (Note 1) | | Pulse (Note 2) | 100 | |
| P _C (Note 3) | Maximum collector dissipation | T _C = 25°C | 320 | W |
| T _j | Junction temperature | | -40 ~ +150 | °C |
| T _{stg} | Storage temperature | | -40 ~ +125 | °C |
| V _{iso} | Isolation voltage | Main terminal to base plate, AC 1 min. | 2500 | V |
| — | Torque strength | Main Terminal M4 | 1.3 ~ 1.7 | N • m |
| | | Mounting holes M5 | 2.5 ~ 3.5 | N • m |
| — | Weight | Typical value | 570 | g |

ELECTRICAL CHARACTERISTICS (Tj = 25°C)

| Symbol | Parameter | Test conditions | Limits | | | Unit |
|--------------------------|--------------------------------------|--|--------|------|--------|------|
| | | | Min. | Typ. | Max. | |
| I _{CES} | Collector cutoff current | V _{CE} = V _{CE} S, V _{GE} = 0V | — | — | 1 | mA |
| V _{GE(th)} | Gate-emitter threshold voltage | I _C = 5.0mA, V _{CE} = 10V | 5 | 6 | 7 | V |
| I _{GES} | Gate leakage current | V _{GE} = V _{CE} S, V _{CE} = 0V | — | — | 20 | µA |
| V _{CE(sat)} | Collector-emitter saturation voltage | T _j = 25°C | — | 1.8 | 2.4 | V |
| | | T _j = 125°C | — | 1.9 | — | |
| C _{ies} | Input capacitance | V _{CE} = 10V V _{GE} = 0V | — | — | 20 | nF |
| C _{oes} | Output capacitance | | — | — | 0.85 | |
| C _{res} | Reverse transfer capacitance | | — | — | 0.5 | |
| Q _G | Total gate charge | V _{CC} = 600V, I _C = 50A, V _{GE} = 15V | — | 550 | — | nC |
| t _{d(on)} | Turn-on delay time | V _{CC} = 600V, I _C = 50A V _{GE1} = V _{GE2} = 15V R _G = 6.3Ω, Inductive load switching operation I _E = 50A | — | — | 100 | ns |
| t _r | Turn-on rise time | | — | — | 50 | |
| t _{d(off)} | Turn-off delay time | | — | — | 300 | |
| t _f | Turn-off fall time | | — | — | 300 | |
| t _{rr} (Note 1) | Reverse recovery time | | — | — | 150 | |
| Q _{rr} (Note 1) | Reverse recovery charge | — | 2.1 | — | µC | |
| V _{EC} (Note 1) | Emitter-collector voltage | I _E = 50A, V _{GE} = 0V | — | — | 3.2 | V |
| R _{th(j-c)Q} | Thermal resistance*1 | IGBT part (1/6 module) | — | — | 0.39 | °C/W |
| R _{th(j-c)R} | | FWDi part (1/6 module) | — | — | 0.70 | |
| R _{th(c-f)} | Contact thermal resistance | Case to fin, Thermal compound applied*2 (1/6 module) | — | 0.11 | — | |
| R _{th(j-c')Q} | Thermal resistance | T _c measured point is just under the chips | — | — | 0.31*3 | |
| R _G | External gate resistance | | 6.3 | — | 63 | Ω |

Note 1. I_E, V_{EC}, t_{rr}, Q_{rr}, die/dt represent characteristics of the anti-parallel, emitter to collector free-wheel diode. (FWDi).

2. Pulse width and repetition rate should be such that the device junction temp. (T_j) does not exceed T_{jmax} rating.

3. Junction temperature (T_j) should not increase beyond 150°C.

4. Pulse width and repetition rate should be such as to cause negligible temperature rise.

*1 : T_c measured point is indicated in OUTLINE DRAWING.

*2 : Typical value is measured by using Shin-etsu Silicone "G-746".

*3 : If you use this value, R_{th(f-a)} should be measured just under the chips.

PERFORMANCE CURVES

OUTPUT CHARACTERISTICS (TYPICAL)

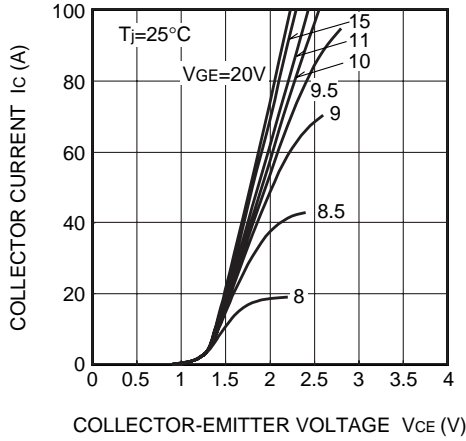

COLLECTOR-EMITTER SATURATION VOLTAGE CHARACTERISTICS (TYPICAL)

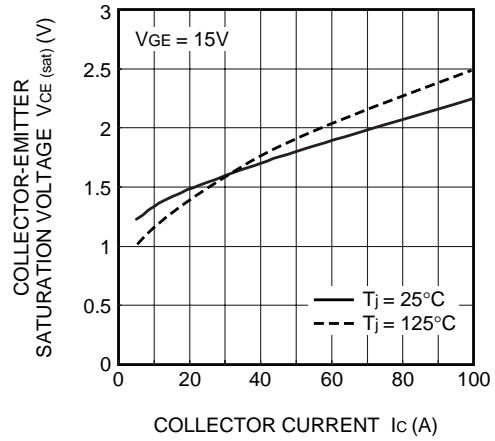

COLLECTOR-EMITTER SATURATION VOLTAGE CHARACTERISTICS (TYPICAL)

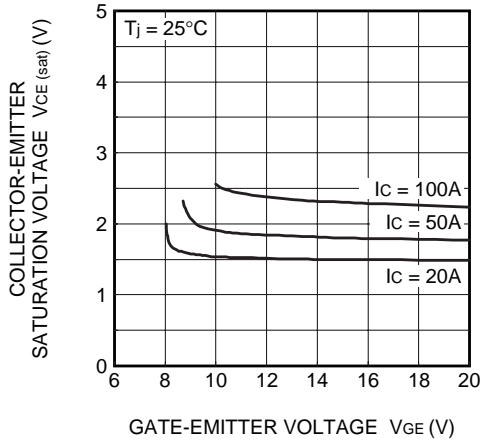

FREE-WHEEL DIODE FORWARD CHARACTERISTICS (TYPICAL)

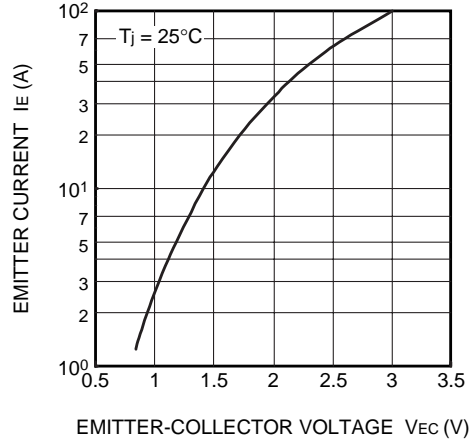

CAPACITANCE-Vce CHARACTERISTICS (TYPICAL)

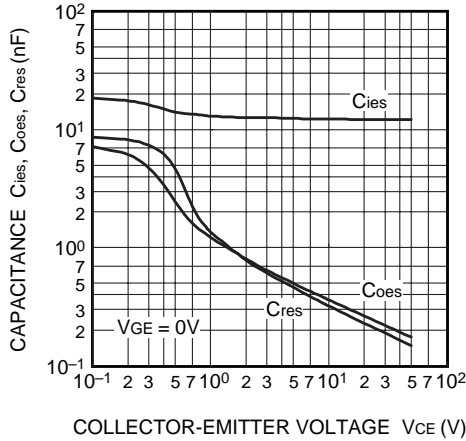

HALF-BRIDGE SWITCHING CHARACTERISTICS (TYPICAL)

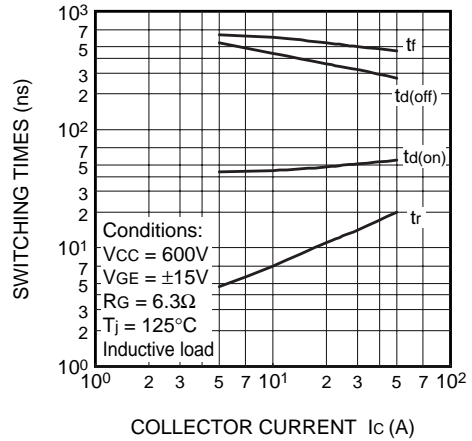

REVERSE RECOVERY CHARACTERISTICS OF FREE-WHEEL DIODE (TYPICAL)

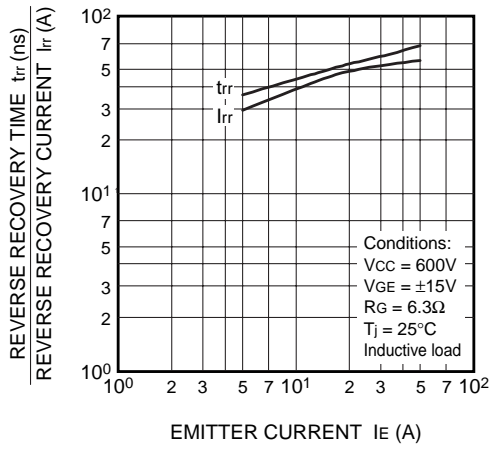

TRANSIENT THERMAL IMPEDANCE CHARACTERISTICS (IGBT part & FWDi part)

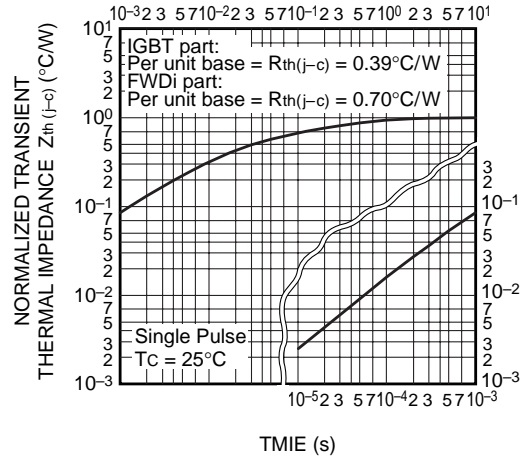

GATE CHARGE CHARACTERISTICS (TYPICAL)

