

PM400DVA060

FLAT-BASE TYPE
INSULATED PACKAGE

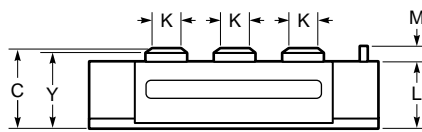
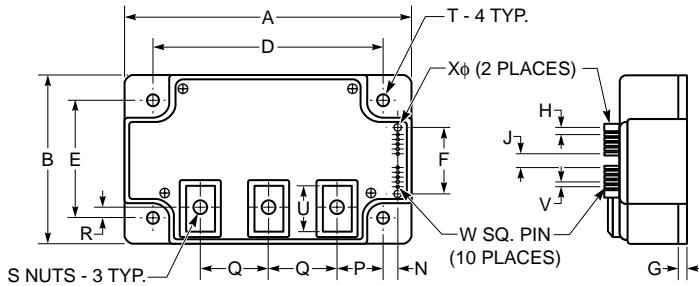

TERMINAL CODE

- | | |
|--------|--------|
| 1. VN1 | 1. VP1 |
| 2. SNR | 2. SPR |
| 3. CN1 | 3. CP1 |
| 4. VNC | 4. VPC |
| 5. FNO | 5. FPO |

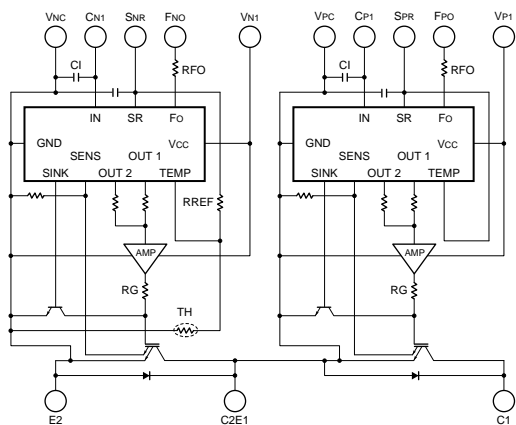

Description:

Mitsubishi Intelligent Power Modules are isolated base modules designed for power switching applications operating at frequencies to 20kHz. Built-in control circuits provide optimum gate drive and protection for the IGBT and free-wheel diode power devices.

Features:

- Complete Output Power Circuit
- Gate Drive Circuit
- Protection Logic
 - Short Circuit
 - Over Temperature
 - Under Voltage

Applications:

- Inverters
- UPS
- Motion/Servo Control
- Power Supplies

Ordering Information:

Example: Select the complete part number from the table below -i.e. PM400DVA060 is a 600V, 400 Ampere Intelligent Power Module.

Type	Current Rating Amperes	V _{CES} Volts (x 10)
PM	400	60

Outline Drawing and Circuit Diagram

Dimensions	Inches	Millimeters
A	4.72	120.0
B	2.76	70.0
C	1.14 +0.04/-0.02	29.0 +1.0/-0.5
D	4.17±0.010	106.0±0.25
E	2.20±0.010	56.0±0.25
F	1.52	38.5
G	0.16	4.0
H	0.16	4.01
J	0.40	10.16
K	0.55	14.0
L	1.02	26.0
M	0.45	11.5

Dimensions	Inches	Millimeters
N	0.12	3.0
P	1.50	38.0
Q	0.98	25.0
R	0.37	9.3
S	M6 Metric	M6
T	0.26 Dia.	Dia. 6.5
U	0.72	18.3
V	0.10	2.54
W	0.025 SQ	0.64 SQ
X	0.14 Dia.	3.5 Dia.
Y	1.10	28.0

PM400DVA060

**FLAT-BASE TYPE
INSULATED PACKAGE**

Absolute Maximum Ratings, $T_j = 25^\circ\text{C}$ unless otherwise specified

Ratings	Symbol	PM400DVA060	Units
Power Device Junction Temperature	T_j	-20 to 150	$^\circ\text{C}$
Storage Temperature	T_{stg}	-40 to 125	$^\circ\text{C}$
Case Operating Temperature	T_C	-20 to 100	$^\circ\text{C}$
Mounting Torque, M6 Mounting Screws	—	3.92~5.88	$\text{N} \cdot \text{m}$
Mounting Torque, M6 Main Terminal Screws	—	3.92~5.88	$\text{N} \cdot \text{m}$
Module Weight (Typical)	—	510	Grams
Supply Voltage (Applied between C1-E2)	$V_{\text{CC(surge)}}$	500	Volts
Supply Voltage Protected by SC ($V_D = 13.5 \sim 16.5\text{V}$, Inverter Part, $T_j = 125^\circ\text{C}$ Start)	$V_{\text{CC(prot.)}}$	400	Volts
Isolation Voltage (Main Terminal to Baseplate, AC 1 min.)	V_{iso}	2500	V_{rms}

Control Sector

Supply Voltage (Applied between $V_{P1}-V_{PC}$, $V_{N1}-V_{NC}$)	V_D	20	Volts
Input Voltage (Applied between $C_{P1}-V_{PC}$, $V_{N1}-V_{NC}$)	V_{CIN}	10	Volts
Fault Output Supply Voltage (Applied between $F_{PO}-V_{PC}$, $F_{NO}-V_{NC}$)	V_{FO}	20	Volts
Fault Output Current (Sink Current at F_{PO} , F_{NO} Terminal)	I_{FO}	20	mA

IGBT Inverter Sector

Collector-Emitter Voltage ($V_D = 15\text{V}$, $V_{\text{CIN}} = 5\text{V}$)	V_{CES}	600	Volts
Collector Current, ($T_C = 25^\circ\text{C}$)	I_C	400	Amperes
Peak Collector Current, ($T_C = 25^\circ\text{C}$)	I_{CP}	800	Amperes
Collector Dissipation ($T_C = 25^\circ\text{C}$)	P_C	1136	Watts

PM400DVA060

FLAT-BASE TYPE
INSULATED PACKAGE

Electrical and Mechanical Characteristics, $T_j = 25^\circ\text{C}$ unless otherwise specified

Characteristics	Symbol	Test Conditions	Min.	Typ.	Max.	Units
Control Sector						
Short Circuit Trip Level	SC	$-20^\circ\text{C} \leq T_j \leq 125^\circ\text{C}$, $V_D = 15\text{V}$	650	910	—	Amperes
Short Circuit Current Delay Time	$t_{\text{off(SC)}}$	$V_D = 15\text{V}$	—	10	—	μs
Over Temperature Protection	OT	Trip Level	100	110	120	$^\circ\text{C}$
($V_D = 15\text{V}$, Lower Arm)	OT_r	Reset Level	85	95	105	$^\circ\text{C}$
Supply Circuit Under Voltage Protection	UV	Trip Level	11.5	12.0	12.5	Volts
($-20^\circ\text{C} \leq T_j \leq 125^\circ\text{C}$)	UV_r	Reset Level	—	12.5	—	Volts
Circuit Current	I_D	$V_D = 15\text{V}$, $V_{\text{CIN}} = 5\text{V}$, $V_{\text{N1}}-V_{\text{NC}}$	—	23	30	mA
		$V_D = 15\text{V}$, $V_{\text{CIN}} = 5\text{V}$, $V_{\text{P1}}-V_{\text{PC}}$	—	23	30	mA
Input ON Threshold Voltage	$V_{\text{th(on)}}$	Applied between	1.2	1.5	1.8	Volts
Input OFF Threshold Voltage	$V_{\text{th(off)}}$	$C_{\text{P1}}-V_{\text{PC}}$, $C_{\text{N1}}-V_{\text{NC}}$	1.7	2.0	2.3	Volts
Fault Output Current	$I_{\text{FO(H)}}$	$V_D = 15\text{V}$, $V_{\text{FO}} = 15\text{V}^*$	—	—	0.01	mA
	$I_{\text{FO(L)}}$	$V_D = 15\text{V}$, $V_{\text{FO}} = 15\text{V}^*$	—	10	15	mA
Minimum Fault Output Pulse Width	t_{FO}	$V_D = 15\text{V}^*$	1.0	1.8	—	ms
SXR Terminal Output Voltage	V_{SXR}	$T_j \leq 125^\circ\text{C}$, $R_{\text{in}} = 6.8\text{k}\Omega$ (S_{PR} , S_{NR})	4.5	5.1	5.6	Volts

* Fault output is given only when the internal SC, OT, and UV protections circuits of either an upper-arm or a lower-arm device operate to protect it.

PM400DVA060

**FLAT-BASE TYPE
INSULATED PACKAGE**

Electrical and Mechanical Characteristics, $T_j = 25^\circ\text{C}$ unless otherwise specified

Characteristics	Symbol	Test Conditions	Min.	Typ.	Max.	Units
IGBT Inverter Sector						
Collector-Emitter Cutoff Current	I_{CES}	$V_{CE} = V_{CES}, V_D = 15\text{V}, T_j = 25^\circ\text{C}$	—	—	1.0	mA
		$V_{CE} = V_{CES}, V_D = 15\text{V}, T_j = 125^\circ\text{C}$	—	—	10.0	mA
FWDi Forward Voltage	V_{EC}	$-I_C = 400\text{A}, V_D = 15\text{V}, V_{CIN} = 5\text{V}$	—	2.20	3.30	Volts
Collector-Emitter Saturation Voltage	$V_{CE(sat)}$	$V_D = 15\text{V}, V_{CIN} = 0\text{V}, I_C = 400\text{A},$ Pulsed, $T_j = 25^\circ\text{C}$	—	2.35	2.80	Volts
		$V_D = 15\text{V}, V_{CIN} = 0\text{V}, I_C = 400\text{A},$ Pulsed, $T_j = 125^\circ\text{C}$	—	2.55	3.05	Volts
Inductive Load Switching Times	t_{on}		0.5	1.4	2.5	μs
	t_{rr}	$V_D = 15\text{V}, V_{CIN} = 0 \leftrightarrow 5\text{V}$	—	0.15	0.3	μs
	$t_{C(on)}$	$V_{CC} = 300\text{V}, I_C = 400\text{A},$ $T_j = 125^\circ\text{C}$	—	0.4	1.0	μs
	t_{off}		—	2.0	3.0	μs
	$t_{C(off)}$		—	0.5	1.0	μs

Thermal Characteristics

Characteristic	Symbol	Condition	Min.	Typ.	Max.	Units
Junction to Case Thermal Resistance	$R_{th(j-c)Q}$	Each Inverter IGBT	—	—	0.11	$^\circ\text{C/Watt}$
	$R_{th(j-c)F}$	Each Inverter FWDi	—	—	0.18	$^\circ\text{C/Watt}$
Contact Thermal Resistance	$R_{th(c-f)}$	Case to Fin Per Module, Thermal Grease Applied	—	—	0.081	$^\circ\text{C/Watt}$

Recommended Conditions for Use

Characteristic	Symbol	Condition	Value	Units
Supply Voltage	V_{CC}	Applied across C1-E2 Terminals	≤ 400	Volts
	$V_{CE(surge)}$	Applied across C1-E1, C2-E2 Terminals	≤ 500	Volts
	V_D	Applied between $V_{P1}-V_{PC}, V_{N1}-V_{NC}$ *	15 ± 1.5	Volts
Input ON Voltage	$V_{CIN(on)}$	Applied between	≤ 0.8	Volts
Input OFF Voltage	$V_{CIN(off)}$	$C_{P1}-V_{PC}, C_{N1}-V_{NC}$	≥ 4.0	Volts
Arm Shoot-Through Blocking Time	t_{DEAD}	For IPM's each Input Signal	≥ 3.5	μs

* With ripple satisfying the following conditions, dv/dt swing $\leq 5\text{V}/\mu\text{s}$, Variation $\leq 2\text{V}$ peak to peak.

PM400DVA060

FLAT-BASE TYPE
INSULATED PACKAGE

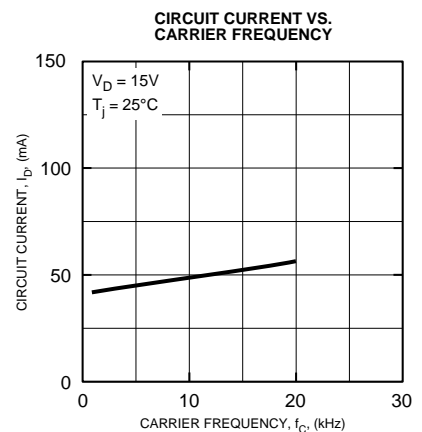
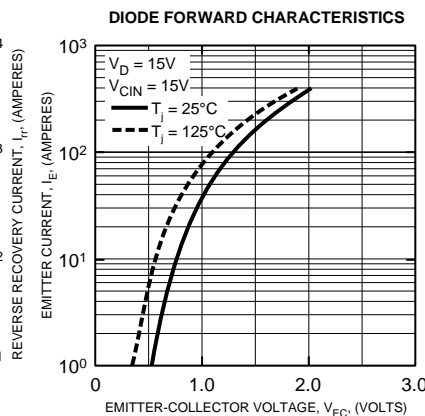
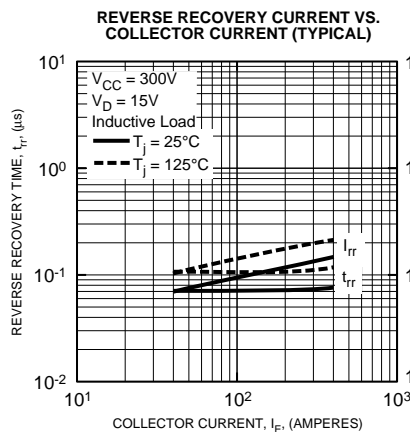
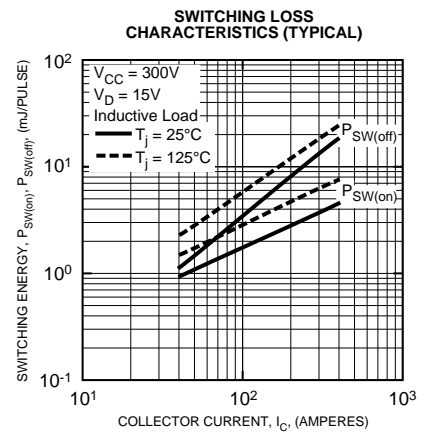
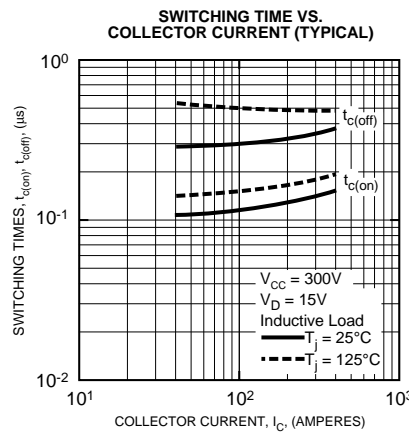
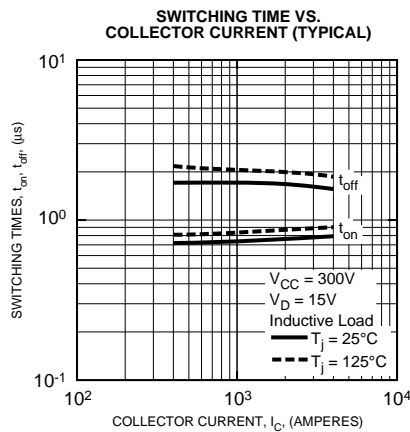
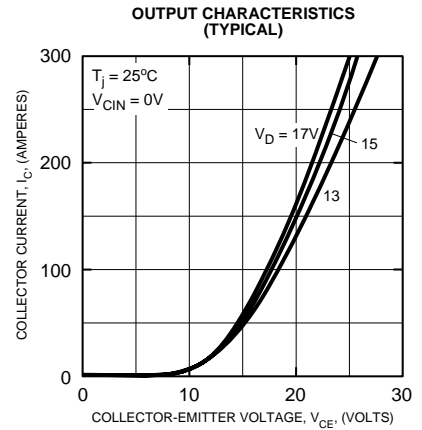
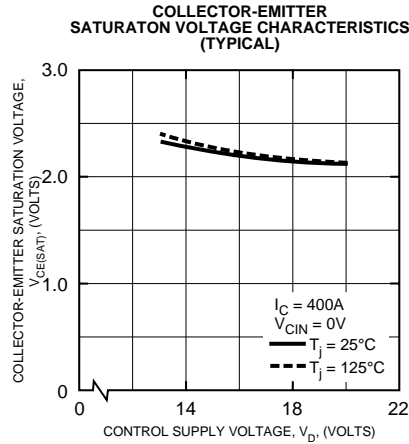
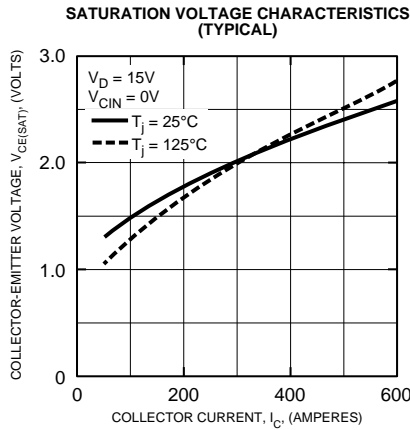

PM400DVA060

FLAT-BASE TYPE
INSULATED PACKAGE

