

PC812

High Noise Resistance Type Photocoupler

■ Features

1. High noise reduction
(Common mode rejection voltage
 V_{CM} : TYP. 1.5kV at $dv/dt = 2kV/\mu s$,
 $R_L = 470\Omega$, $V_{np} = 100mV$)
2. High current transfer ratio
(CTR : MIN. 90% at $I_F = 5mA$, $V_{CE} = 5V$)
3. High isolation voltage between input and output (V_{iso} : 5 000V_{rms})
4. Compact dual-in-line package

■ Applications

1. Motor-control circuits
2. Computer terminals
3. System appliances, measuring instruments
4. Signal transmission between circuits of different potentials and impedances

■ Outline Dimensions

(Unit : mm)

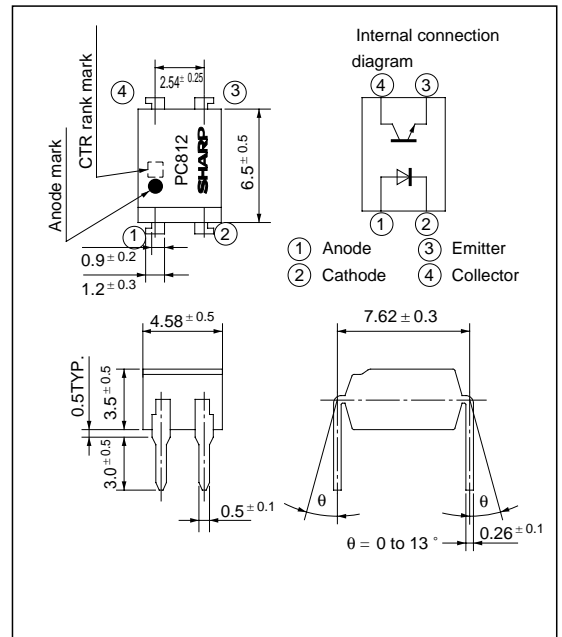

■ Absolute Maximum Ratings

($T_a = 25^\circ C$)

Parameter		Symbol	Rating	Unit
Input	Forward current	I_F	50	mA
	*1 Peak forward current	I_{FM}	1	A
	Reverse voltage	V_R	6	V
	Power dissipation	P	70	mW
Output	Collector-emitter voltage	V_{CEO}	35	V
	Emitter-collector voltage	V_{ECO}	6	V
	Collector current	I_C	50	mA
	Collector power dissipation	P_C	150	mW
	Total power dissipation	P_{tot}	200	mW
*2 Isolation voltage		V_{iso}	5 000	V _{rms}
Operating temperature		T_{opr}	- 30 to + 100	°C
Storage temperature		T_{stg}	- 55 to + 125	°C
*3 Soldering temperature		T_{sol}	260	°C

*1 Pulse width $\leq 100\mu s$, Duty ratio : 0.001

*2 40 to 60% RH, AC for 1 minute

*3 For 10 seconds

■ Electro-optical Characteristics

($T_a = 25^\circ\text{C}$)

Parameter		Symbol	Conditions	MIN.	TYP.	MAX.	Unit	
Input	Forward voltage	V_F	$I_F = 20\text{mA}$	-	1.2	1.4	V	
	Peak forward voltage	V_{FM}	$I_{FM} = 0.5\text{A}$	-	-	3.0	V	
	Reverse current	I_R	$V_R = 4\text{V}$	-	-	10	μA	
	Terminal capacitance	C_t	$V = 0, f = 1\text{kHz}$	-	30	200	pF	
Output	Collector dark current	I_{CEO}	$V_{CE} = 20\text{V}, I_F = 0$	-	-	10^{-7}	A	
Transfer characteristics	*4 Current transfer ratio	CTR	$I_F = 5\text{mA}, V_{CE} = 5\text{V}$	90	-	480	%	
	Collector-emitter saturation voltage	$V_{CE(sat)}$	$I_F = 20\text{mA}, I_C = 1\text{mA}$	-	0.1	0.2	V	
	Isolation resistance	R_{ISO}	DC500V, 40 to 60% RH	5×10^{10}	10^{11}	-	Ω	
	Floating capacitance	C_f	$V = 0, f = 1\text{MHz}$	-	0.6	1.0	pF	
	*4 Response time	Cut-off frequency	f_c	$V_{CE} = 5\text{V}, I_C = 2\text{mA}, R_L = 100\Omega, -3\text{dB}$	15	80	-	kHz
			Rise time	t_r	$V_{CE} = 2\text{V}, I_C = 2\text{mA}, R_L = 100\Omega$	-	4	18
	Fall time	t_f	$V_{CE} = 2\text{V}, I_C = 2\text{mA}, R_L = 100\Omega$	-	5	20	μs	
*5 Common mode rejection voltage		V_{CM}	$dv/dt = 2\text{kV}/\mu\text{s}, R_L = 470\Omega, V_{np} = 100\text{mV}, I_F = 0$	-	1.5	-	kV	

*4 Classification table of current transfer ratio is shown below.

Model No.	Rank mark	CTR (%)	$t_r (\mu\text{s})$		$t_f (\mu\text{s})$	
			TYP.	MAX.	TYP.	MAX.
PC812A	A	90 to 180	3	14	4	16
PC812B	B	150 to 180	4	16	5	18
PC812C	C	240 to 480	5	18	7	20
PC812	A, B or C	90 to 480	4	18	5	20

Measurement conditions	$I = 5\text{mA}$ $V_{CE} = 5\text{V}$ $T_a = 25^\circ\text{C}$	$V_{CE} = 2\text{V}$
		$I_C = 2\text{mA}$ $R_L = 100\Omega$ $T_a = 25^\circ\text{C}$

*5 Test Circuit for V_{CM}

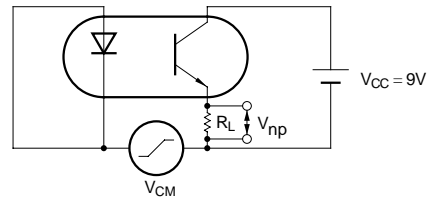

V_{CM} : Common mode rejection voltage
(higher value of pulse wave)
 dv/dt : Rising factor of voltage

Test condition
 $V_{np} = 100\text{mV}, R_L = 470\Omega$
 $dv/dt = 2\text{kV}/\mu\text{s}, I_F = 0$

Fig. 1 Forward Current vs. Ambient Temperature

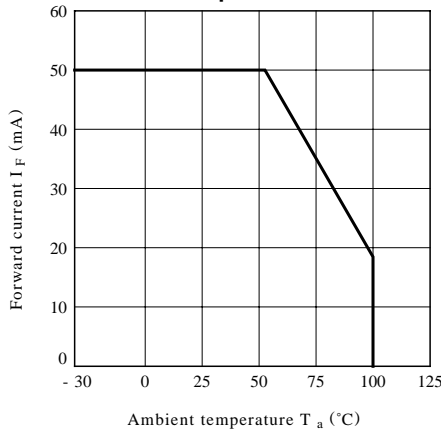

Fig. 2 Collector Power Dissipation vs. Ambient Temperature

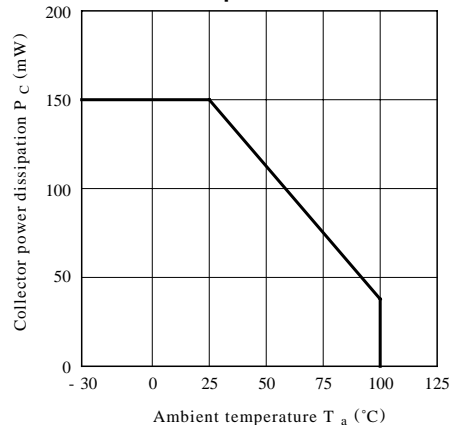

Fig. 3 Peak Forward Current vs. Duty Ratio

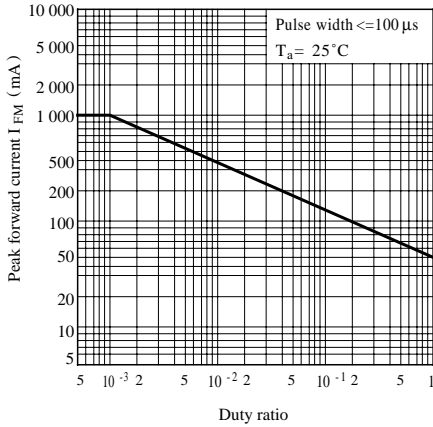

Fig. 4 Forward Current vs. Forward Voltage

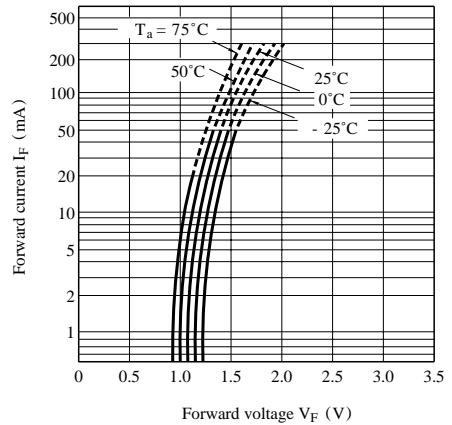

Fig. 5 Current Transfer Ratio vs. Forward Current

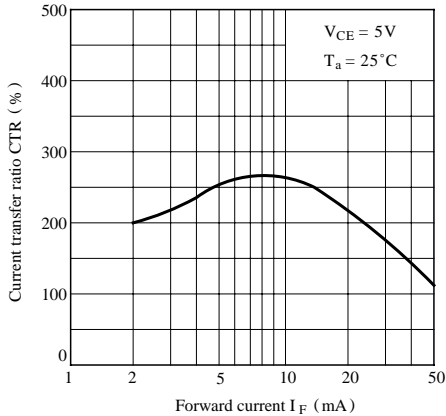

Fig. 6 Collector Current vs. Collector-emitter Voltage

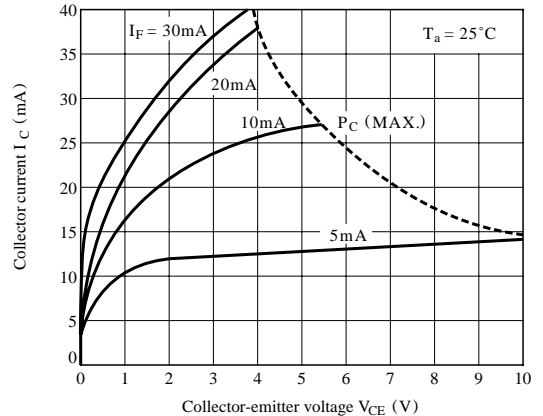

Fig. 7 Relative Current Transfer Ratio vs. Ambient Temperature

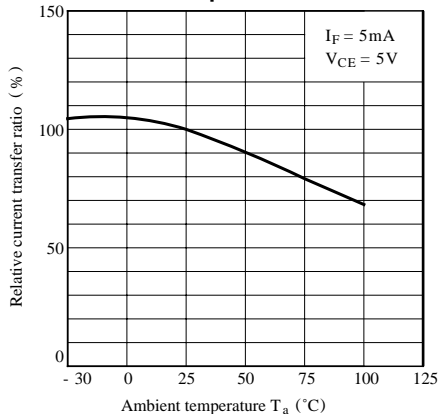

Fig. 8 Collector-emitter Saturation Voltage vs. Ambient Temperature

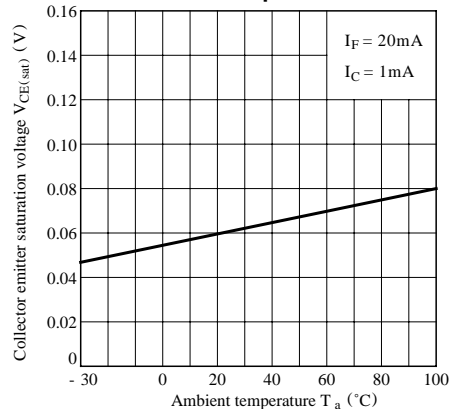

Fig. 9 Collector Dark Current vs. Ambient Temperature

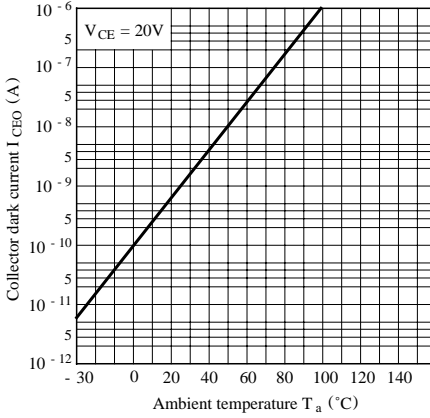

Fig.10 Response Time vs. Load Resistance

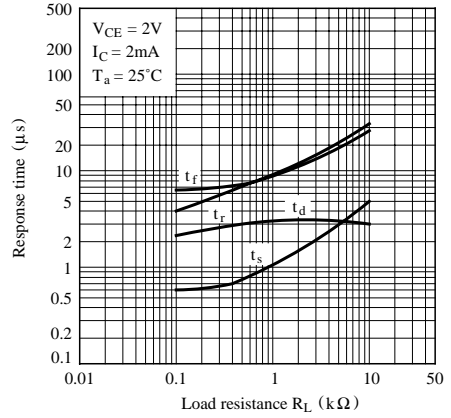
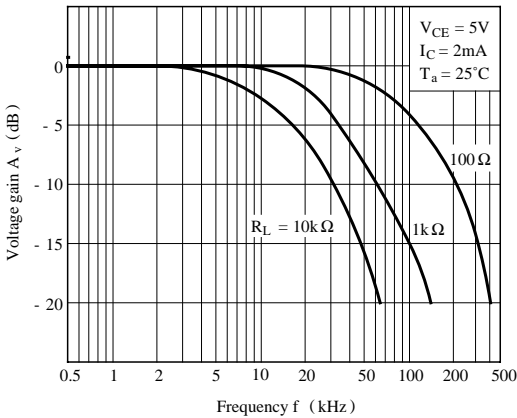

Fig.11 Frequency Response



Test Circuit for Response Time

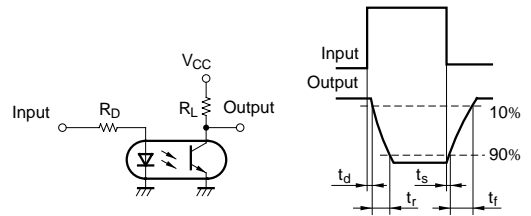
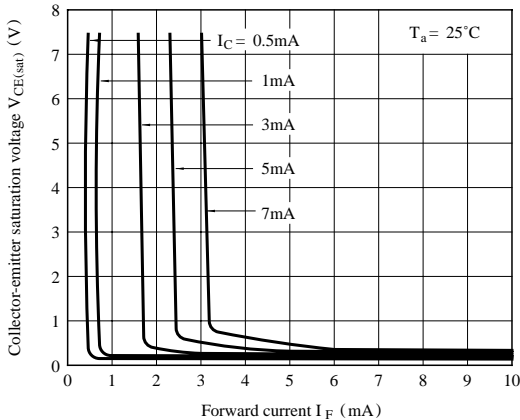
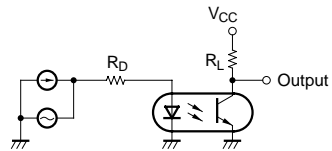

Fig.12 Collector-emitter Saturation Voltage vs. Forward Current



Test Circuit for Frequency Response



● Please refer to the chapter "Precautions for Use"