

IGBT MODULE (F series)

■ Features

- Low Saturation Voltage
- Voltage Drive
- Variety of Power Capacity Series

■ Applications

- Inverter for Motor Drive
- AC and DC Servo Drive Amplifier
- Uninterruptible Power Supply
- Industrial Machines, such as Welding Machines

■ Maximum Ratings and Characteristics

● Absolute Maximum Ratings

Items	Symbols	Ratings	Units
Collector-Emitter Voltage	V _{CES}	1200	V
Gate-Emitter Voltage	V _{GES}	±20	V
Collector Current	Continuous	I _C	8
	1ms	I _C pulse	16
	Continuous	-I _C	8
	1ms	-I _C pulse	16
Max. Power Dissipation	P _C	60	W
Operating Temperature	T _J	+150	°C
Storage Temperature	T _{stg}	-40 to +125	°C
Net. Weight		150	g
Isolation Voltage	AC, 1min.	V _{isol}	2500 V
Screw Torque	Mounting *1	3.5 [35]	N · m
	Terminals	—	(kg · cm)

*1 Recommendable Value 2.5 to 3.5 N·m {25 to 35 kg·cm} (M5)

● Electrical Characteristics (T_c=25°C)

Items	Symbols	Test Conditions	Min.	Typ.	Max.	Units
Zero Gate Voltage Collector Current	I _{CES}	V _{GE} =0V V _{CE} =1200V T _J =25°C			1.0	mA
		V _{GE} =0V V _{CE} =1200V T _J =125°C			—	mA
Gate-Emitter Leakage Current	I _{GES}	V _{CE} =0V V _{GE} =±20V			100	nA
Gate-Emitter Threshold Voltage	V _{GE(th)}	V _{CE} =20V I _C =8mA	3.0		6.0	V
Collector-Emitter Saturation Voltage	V _{CE(sat)}	V _{GE} =15V I _C =8A			2.5	V
Input Capacitance	C _{ies}	V _{GE} =0V		1450		pF
Output Capacitance	C _{oes}	V _{CE} =10V				
Reverse Transfer Capacitance	C _{res}	f=1MHz				
Turn-on Time	t _{on}	V _{CC} =600V	Resistive load			0.8
	t _r	I _C =8A				0.6
Turn-off Time	t _{off}	V _{GE} =±15V	Inductive load			1.5
	t _r	R _G =150Ω				1.0
Diode Forward On-Voltage	V _F	I _F =8A, V _{GE} =0V			2.5	V
Reverse Recovery Time	t _{rr}	I _F =8A, -di/dt=50A/μs V _{GE} =-10V			350	ns

● Thermal Characteristics

Items	Symbols	Test Conditions	Min.	Typ.	Max.	Units
Thermal Resistance	R _{th(j-c)}	IGBT			2.08	°C/W
	R _{th(j-c)}	Diode			3.30	
	R _{th(c-f)}	With Thermal compound		0.06		

■ Outline Drawings

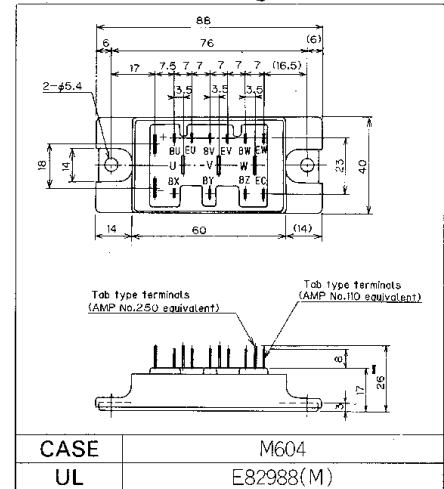

■ Equivalent Circuit Schematic

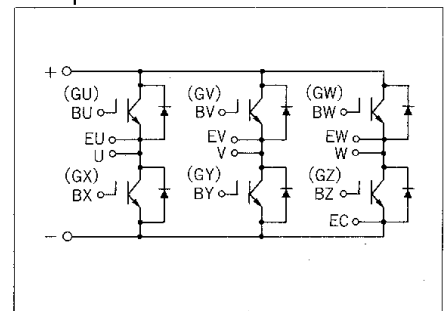

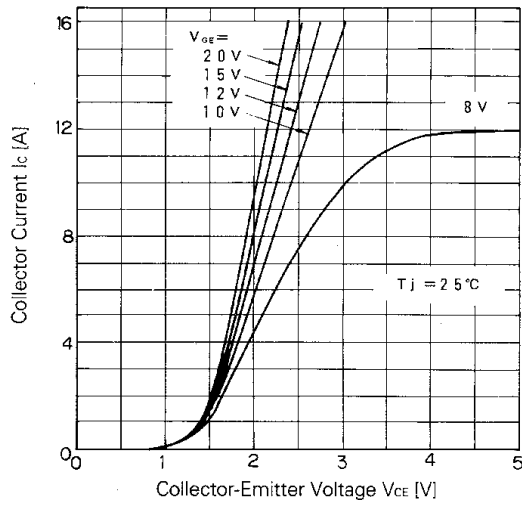

Collector Current vs. Collector-Emitter Voltage

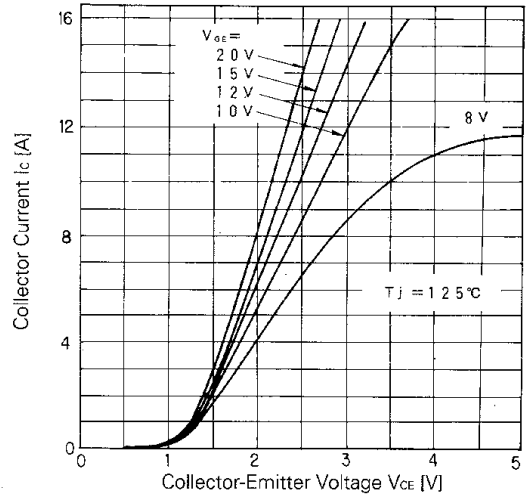

Collector Current vs. Collector-Emitter Voltage

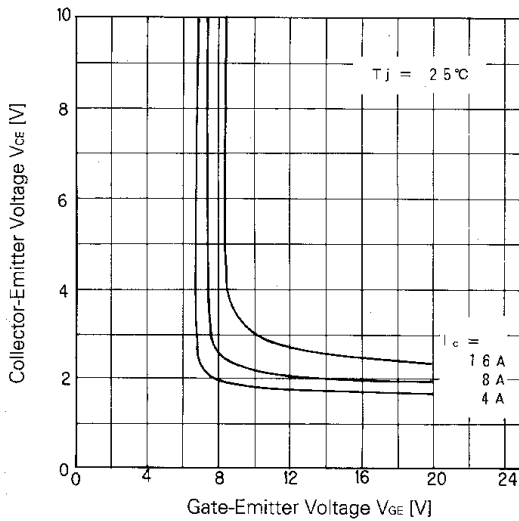

Collector-Emitter Voltage vs. Gate-Emitter Voltage

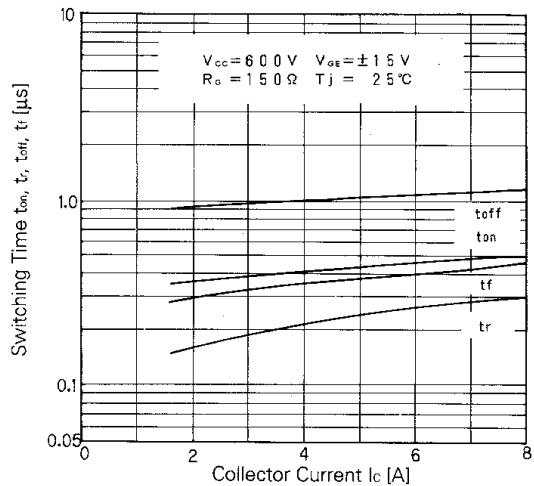

Switching Time

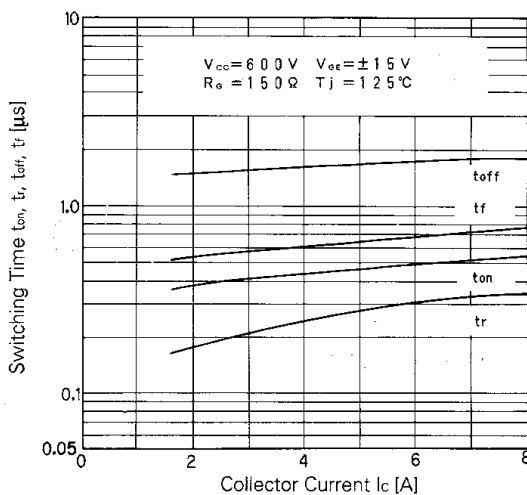

Switching Time

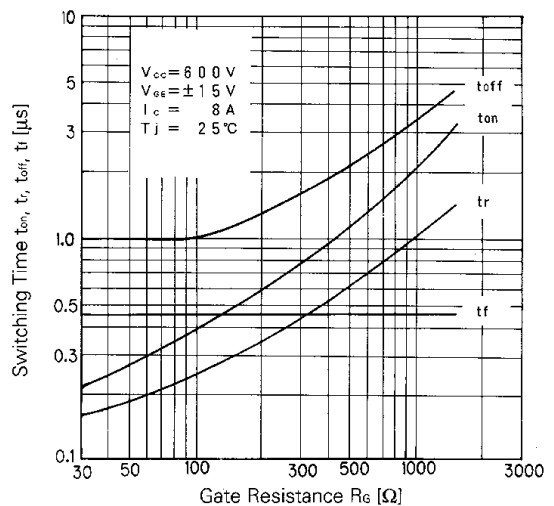

Switching Time-Gate Resistance

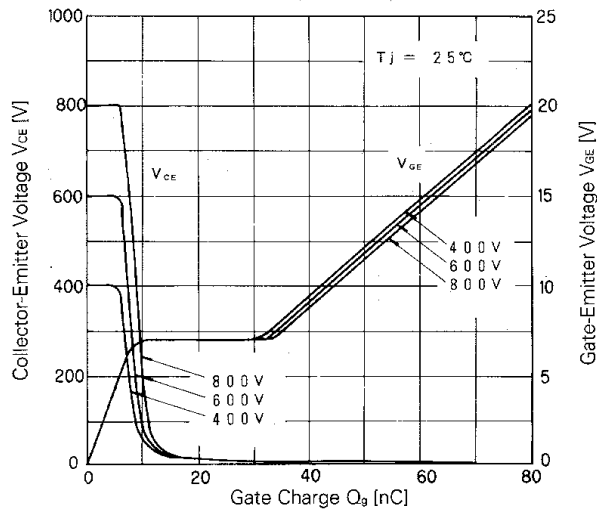

Dynamic Input Characteristic

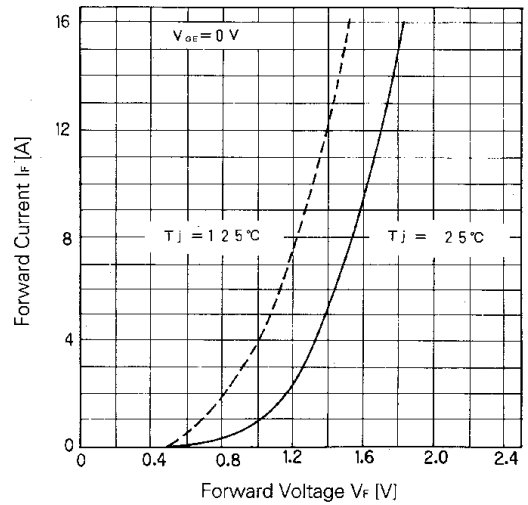

Forward Voltage of Free Wheel Diode

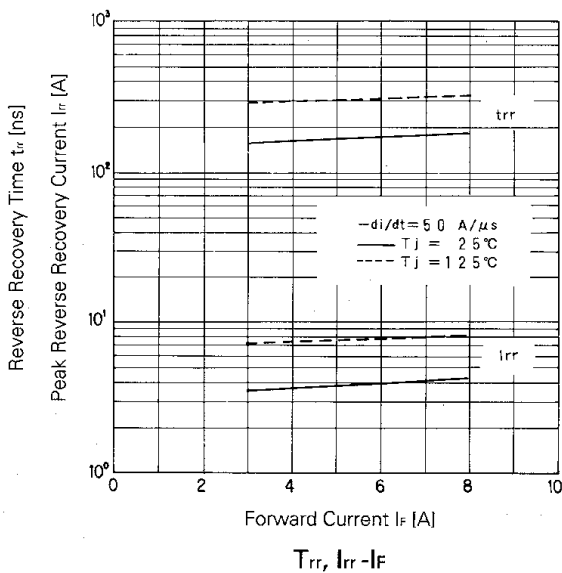

$T_{rr}, I_{rr} - I_f$

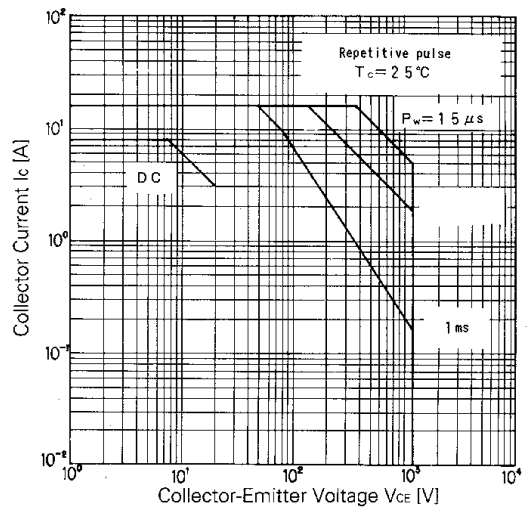

Safe Operating Area

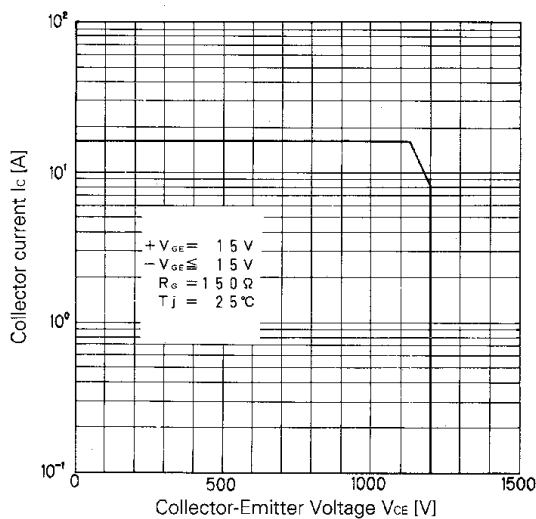

Reverse Biased Safe Operating Area

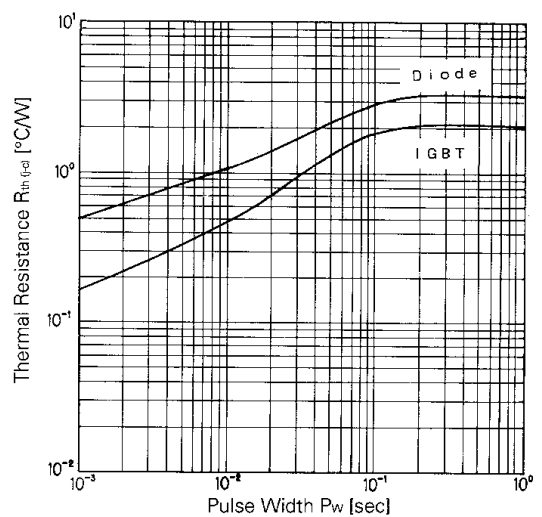

Transient Thermal Resistance

For more information, contact:

Collmer Semiconductor, Inc.

P.O. Box 702708

Dallas, TX 75370

972-733-1700

972-381-9991 Fax

<http://www.collmer.com>