

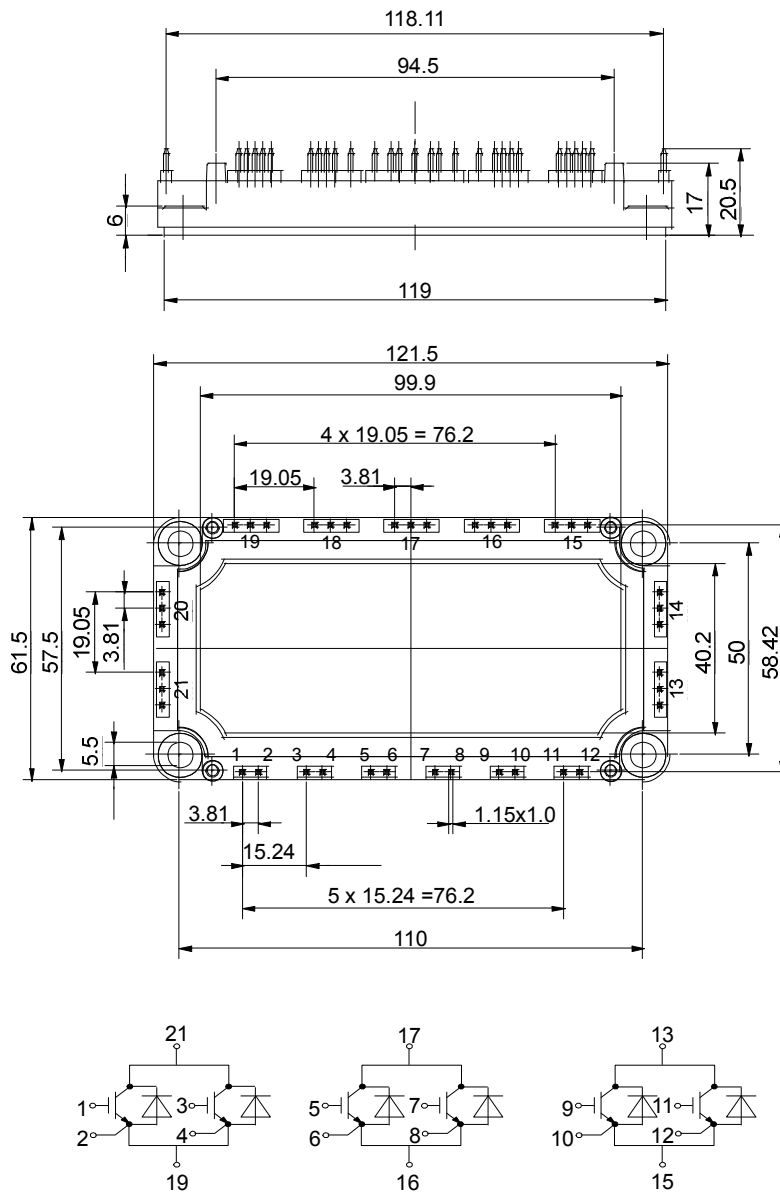

Semiconductor and  
Electronics Company

# Marketing Information

## BSM 150 GT 170 DL



# BSM 150 GT 170 DL

## Höchstzulässige Werte / Maximum rated values

### Elektrische Eigenschaften / Electrical properties

		vorläufige Daten preliminary data	
Kollektor-Emitter-Sperrspannung	collector-emitter voltage	$V_{CES}$	1700 V
Kollektor-Dauergleichstrom	DC-collector current	$I_{C,nom.}$	150 A
		$I_C$	300 A
Periodischer Kollektor Spitzenstrom	repetitive peak collector current	$I_{CRM}$	300 A
Gesamt-Verlustleistung	total power dissipation	$P_{tot}$	1250 W
Gate-Emitter-Spitzenspannung	gate-emitter peak voltage	$V_{GES}$	$\pm 20$ V
Dauergleichstrom	DC forward current	$I_F$	150 A
Periodischer Spitzenstrom	repetitive peak forw. current	$I_{FRM}$	300 A
Grenzlastintegral der Diode	$I^2t$ - value, Diode	$I^2t$	7200 A <sup>2</sup> s
Isolations-Prüfspannung	insulation test voltage	$V_{ISOL}$	3,4 kV

### Charakteristische Werte / Characteristic values: Transistor

		min.	typ.	max.
Kollektor-Emitter Sättigungsspannung	collector-emitter saturation voltage	$V_{CE sat}$	-	2,7 - 3,3 V
			-	3,2 - - V
Gate-Schwellenspannung	gate threshold voltage	$V_{GE(th)}$	4,5	5,5 - 6,5 V
Eingangskapazität	input capacitance	$C_{ies}$	-	10 - nF
Kollektor-Emitter Reststrom	collector-emitter cut-off current	$I_{CES}$	-	0,05 - 0,3 mA
			-	4 - mA
Gate-Emitter Reststrom	gate-emitter leakage current	$I_{GES}$	-	- 200 nA
Einschaltverzögerungszeit (induktive Last)	turn-on delay time (inductive load)	$t_{d,on}$	-	-
			-	0,1 - $\mu$ s
			-	0,1 - $\mu$ s
Anstiegszeit (induktive Last)	rise time (inductive load)	$t_r$	-	0,1 - $\mu$ s
			-	0,1 - $\mu$ s
Abschaltverzögerungszeit (ind. Last)	turn off delay time (inductive load)	$t_{d,off}$	-	0,8 - $\mu$ s
			-	0,9 - $\mu$ s
Fallzeit (induktive Last)	fall time (inductive load)	$t_f$	-	0,03 - $\mu$ s
			-	0,03 - $\mu$ s
Einschaltverlustenergie pro Puls	turn-on energy loss per pulse	$E_{on}$	-	70 - mWs
Abschaltverlustenergie pro Puls	turn-off energy loss per pulse	$E_{off}$	-	46 - mWs
Kurzschlußverhalten	SC Data	$I_{SC}$	-	600 - A
			-	25 - nH
Modulinduktivität	stray inductance module	$L_{sCE}$	-	-

### Charakteristische Werte / Characteristic values: Diode

Durchlaßspannung	forward voltage	$V_F$	-	2,2 - 2,6 V
			-	2 - V
Rückstromspitze	peak reverse recovery current	$I_{RM}$	-	110 - A
			-	165 - A
Sperrverzögerungsladung	recovered charge	$Q_r$	-	17 - $\mu$ As
			-	38 - $\mu$ As
Abschaltenergie pro Puls	reverse recovery energy	$E_{rec}$	-	8 - mWs
			-	15 - mWs

### Thermische Eigenschaften / Thermal properties

Innerer Wärmewiderstand	thermal resistance, junction to case	Transistor / transistor, DC	$R_{thJC}$	-	-	0,1 K/W
		Diode / diode, DC		-	-	0,24 K/W
Übergangs-Wärmewiderstand	thermal resistance, case to heatsink	pro Module / per Module	$R_{thCK}$	-	-	0,012 K/W
		$d_{paste} \leq 50\mu m / d_{grease} \leq 50\mu m$		-	-	150 °C
Höchstzul. Sperrschichttemperatur	max. junction temperature		$T_{vj}$	-	-	125 °C
Betriebstemperatur	operating temperature		$T_{op}$	-40	-	125 °C
Lagertemperatur	storage temperature		$T_{stg}$	-40	-	125 °C

### Mechanische Eigenschaften / Mechanical properties

Innere Isolation	internal insulation				$Al_2O_3$
Kriechstrecke	creepage distance				20 mm
Luftstrecke	clearance				11 mm
CTI	comperative tracking index				225
Anzugsdrehmoment f. mech. Befestigung	mounting torque		max.		5 Nm
Gewicht	weight		G		300 g

Mit dieser technischen Information werden Halbleiterbauelemente spezifiziert, jedoch keine Eigenschaften zugesichert. Sie gilt in Verbindung mit den zugehörigen Technischen Erläuterungen.  
This technical information specifies semiconductor devices but promises no characteristics. It is valid in combination with the belonging technical notes.

# BSM 150 GT 170 DL



Bild / Fig. 1  
Ausgangskennlinie (typisch) /  
Output characteristic (typical)  
 $I_C = f(V_{CE})$   
 $V_{GE} = 15V$



Bild / Fig. 2  
Ausgangskennlinienfeld (typisch) /  
Output characteristic (typical)  
 $I_C = f(V_{CE})$   
 $T_{vj} = 125^\circ C$

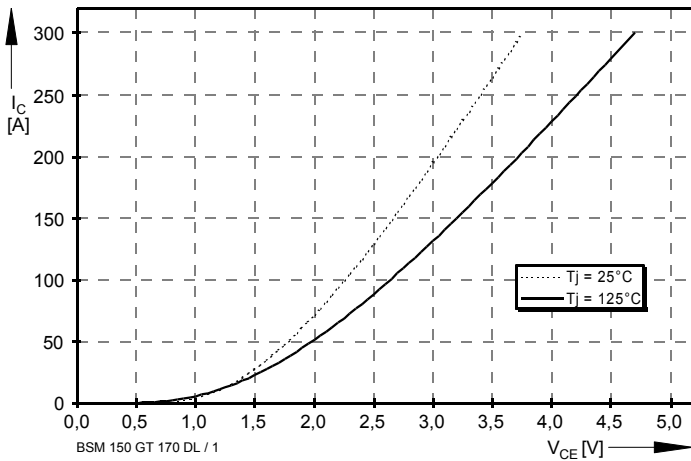

Bild / Fig. 3  
Übertragungscharakteristic (typisch) /  
Transfer characteristic (typical)  
 $I_C = f(V_{GE})$   
 $V_{CE} = 20V$

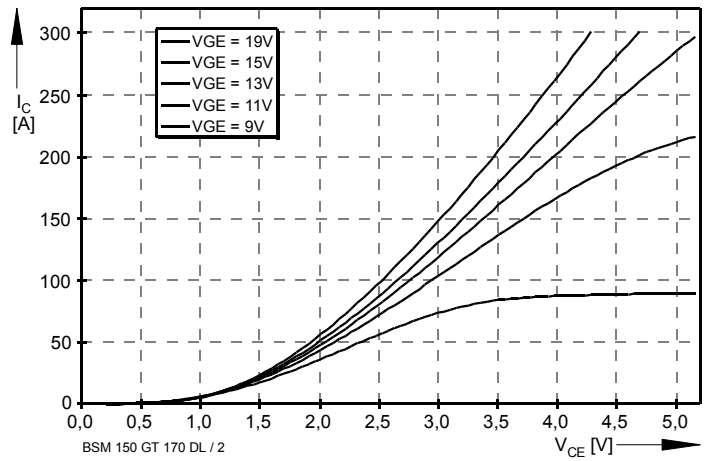

Bild / Fig. 4  
Durchlaßkennlinie der Inversdiode (typisch) /  
Forward characteristic of inverse diode (typical)  
 $I_F = f(V_F)$

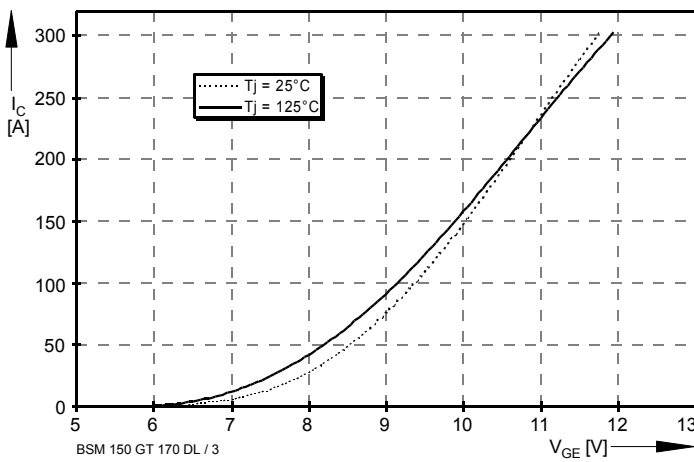

Bild / Fig. 5  
Schaltverluste (typisch) /  
Switching losses (typical)  
 $E_{on} = f(I_C)$ ,  $E_{off} = f(I_C)$ ,  $E_{rec} = f(I_C)$   
 $R_{gon} = R_{goff} = 10\Omega$ ,  $V_{CE} = 900V$ ,  $T_J = 125^\circ C$

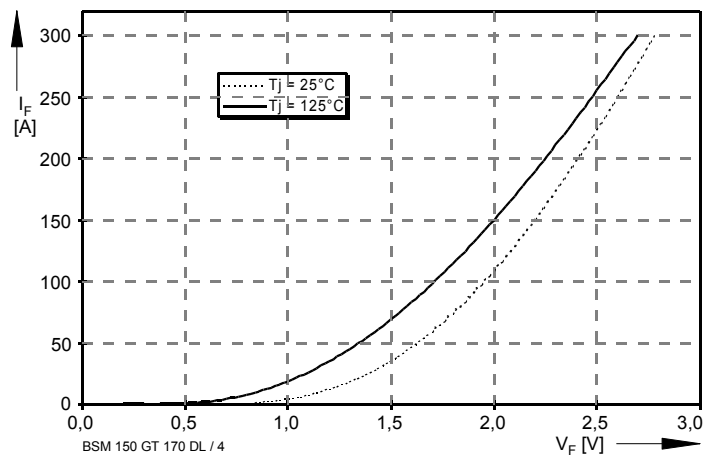

Bild / Fig. 6  
Schaltverluste (typisch) /  
Switching losses (typical)  
 $E_{on} = f(R_G)$ ,  $E_{off} = f(R_G)$ ,  $E_{rec} = f(R_G)$   
 $I_C = 150A$ ,  $V_{CE} = 900V$ ,  $T_J = 125^\circ C$

# BSM 150 GT 170 DL

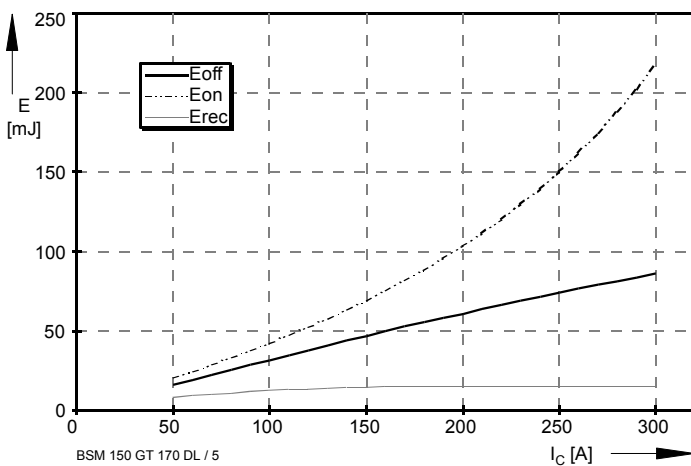
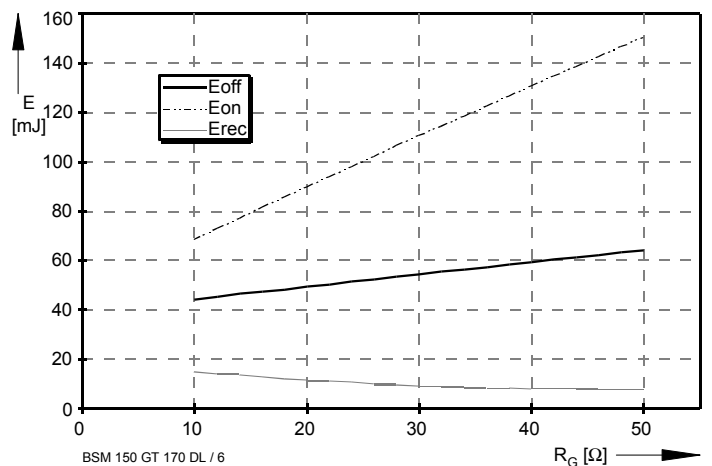
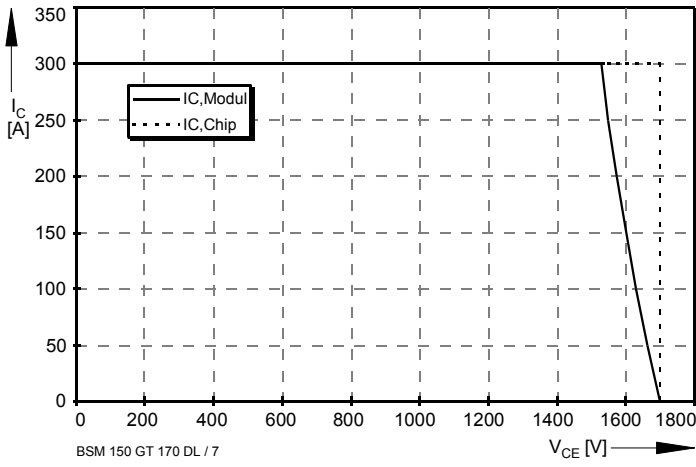

Bild / Fig. 7  
Sicherer Arbeitsbereich (RBSOA) /  
Reverse bias safe operation area (RBSOA)  
 $R_g = 10\Omega$ ,  $T_{vj} = 125^\circ\text{C}$