



# Hybrid Power Module

## Integrated Power Stage for 1.0 hp Motor Drives

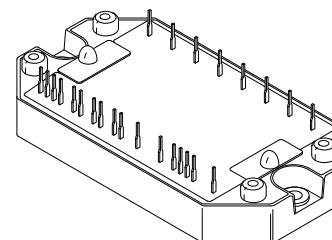
The MHPM7A15A60A module integrates a 3-phase input rectifier bridge, 3-phase output inverter, brake transistor/diode, current sense resistor and temperature sensor in a single convenient package. The output inverter utilizes advanced insulated gate bipolar transistors (IGBT) matched with free-wheeling diodes to give optimal dynamic performance. It has been configured for use as a three-phase motor drive module or for many other power switching applications. The top connector pins have been designed for easy interfacing to the user's control board.

- DC Bus Current Sense Resistor Included
- Short Circuit Rated 10  $\mu$ s @ 25°C
- Temperature Sensor Included
- Pin-to-Baseplate Isolation exceeds 2500 Vac (rms)
- Convenient Package Outline
- UL  Recognized and Designed to Meet VDE 
- Access to Positive and Negative DC Bus

**MHPM7A15A60A**

Motorola Preferred Device

**15 AMP, 600 VOLT  
HYBRID POWER MODULE**



PLASTIC PACKAGE  
CASE 440-01, Style 1

### MAXIMUM DEVICE RATINGS ( $T_J = 25^\circ\text{C}$ unless otherwise noted)

Rating	Symbol	Value	Unit
<b>INPUT RECTIFIER BRIDGE</b>			
Repetitive Peak Reverse Voltage	$V_{RRM}$	600	V
Average Output Rectified Current	$I_O$	15	A
Peak Non-repetitive Surge Current — (1/2 Cycle) (1)	$I_{FSM}$	200	A
<b>OUTPUT INVERTER</b>			
IGBT Reverse Voltage	$V_{CES}$	600	V
Gate-Emitter Voltage	$V_{GES}$	$\pm 20$	V
Continuous IGBT Collector Current	$I_C$	15	A
Peak IGBT Collector Current — (PW = 1.0 ms) (2)	$I_{C(pk)}$	30	A
Continuous Free-Wheeling Diode Current	$I_F$	15	A
Peak Free-Wheeling Diode Current — (PW = 1.0 ms) (2)	$I_{F(pk)}$	30	A
IGBT Power Dissipation	$P_D$	55	W
Free-Wheeling Diode Power Dissipation	$P_D$	30	W
IGBT Junction Temperature Range	$T_J$	- 40 to +125	$^\circ\text{C}$
Free-Wheeling Diode Junction Temperature Range	$T_J$	- 40 to +125	$^\circ\text{C}$

(1) 1 cycle = 50 or 60 Hz

(2) 1.0 ms = 1.0% duty cycle

**Preferred** devices are Motorola recommended choices for future use and best overall value.

**MAXIMUM DEVICE RATINGS (continued)** ( $T_J = 25^\circ\text{C}$  unless otherwise noted)

Rating	Symbol	Value	Unit
<b>BRAKE CIRCUIT</b>			
IGBT Reverse Voltage	$V_{CES}$	600	V
Gate-Emitter Voltage	$V_{GES}$	$\pm 20$	V
Continuous IGBT Collector Current	$I_C$	15	A
Peak IGBT Collector Current (PW = 1.0 ms) (2)	$I_{C(pk)}$	30	A
IGBT Power Dissipation	PD	55	W
Diode Reverse Voltage	$V_{RRM}$	600	V
Continuous Output Diode Current	$I_F$	15	A
Peak Output Diode Current (PW = 1.0 ms) (2)	$I_{F(pk)}$	30	A

**TOTAL MODULE**

Isolation Voltage — (47–63 Hz, 1.0 Minute Duration)	$V_{ISO}$	2500	VAC
Ambient Operating Temperature Range	$T_A$	- 40 to + 85	$^\circ\text{C}$
Operating Case Temperature Range	$T_C$	- 40 to + 90	$^\circ\text{C}$
Storage Temperature Range	$T_{stg}$	- 40 to +150	$^\circ\text{C}$
Mounting Torque	—	6.0	lb-in

**ELECTRICAL CHARACTERISTICS** ( $T_J = 25^\circ\text{C}$  unless otherwise noted)

Characteristic	Symbol	Min	Typ	Max	Unit
<b>INPUT RECTIFIER BRIDGE</b>					
Reverse Leakage Current ( $V_{RRM} = 600\text{ V}$ )	$I_R$	—	10	50	$\mu\text{A}$
Forward Voltage ( $I_F = 15\text{ A}$ )	$V_F$	—	1.05	1.5	V
Thermal Resistance (Each Die)	$R_{\theta JC}$	—	—	2.9	$^\circ\text{C/W}$

**OUTPUT INVERTER**

Gate-Emitter Leakage Current ( $V_{CE} = 0\text{ V}$ , $V_{GE} = \pm 20\text{ V}$ )	$I_{GES}$	—	—	$\pm 20$	$\mu\text{A}$
Collector-Emitter Leakage Current ( $V_{CE} = 600\text{ V}$ , $V_{GE} = 0\text{ V}$ ) $T_J = 25^\circ\text{C}$ $T_J = 125^\circ\text{C}$	$I_{CES}$	— —	— —	200 2.0	$\mu\text{A}$ mA
Gate-Emitter Threshold Voltage ( $V_{CE} = V_{GE}$ , $I_C = 1.0\text{ mA}$ )	$V_{GE(th)}$	4.0	6.0	8.0	V
Collector-Emitter Breakdown Voltage ( $I_C = 10\text{ mA}$ , $V_{GE} = 0$ )	$V_{(BR)CES}$	600	700	—	V
Collector-Emitter Saturation Voltage ( $V_{GE} = 15\text{ V}$ , $I_C = 15\text{ A}$ )	$V_{CE(SAT)}$	—	2.7	3.5	V
Input Capacitance ( $V_{GE} = 0\text{ V}$ , $V_{CE} = 10\text{ V}$ , $f = 1.0\text{ MHz}$ )	$C_{ies}$	—	950	—	pF
Input Gate Charge ( $V_{CE} = 300\text{ V}$ , $I_C = 15\text{ A}$ , $V_{GE} = 15\text{ V}$ )	$Q_T$	—	75	—	nC
Fall Time — Inductive Load ( $V_{CE} = 300\text{ V}$ , $I_C = 15\text{ A}$ , $V_{GE} = 15\text{ V}$ , $R_G = 150\ \Omega$ )	$t_{fi}$	—	200	350	ns
Turn-On Energy ( $V_{CE} = 300\text{ V}$ , $I_C = 15\text{ A}$ , $V_{GE} = 15\text{ V}$ , $R_G = 150\ \Omega$ )	$E_{(on)}$	—	—	1.0	mJ
Turn-Off Energy ( $V_{CE} = 300\text{ V}$ , $I_C = 15\text{ A}$ , $V_{GE} = 15\text{ V}$ , $R_G = 150\ \Omega$ )	$E_{(off)}$	—	—	1.0	mJ
Diode Forward Voltage ( $I_F = 15\text{ A}$ , $V_{GE} = 0\text{ V}$ )	$V_F$	—	1.5	2.0	V
Diode Reverse Recovery Time ( $I_F = 15\text{ A}$ , $V = 400\text{ V}$ , $di/dt = 50\text{ A}/\mu\text{s}$ )	$t_{rr}$	—	140	200	ns
Diode Stored Charge ( $I_F = 15\text{ A}$ , $V = 400\text{ V}$ , $di/dt = 50\text{ A}/\mu\text{s}$ )	$Q_{rr}$	—	—	900	nC
Thermal Resistance — IGBT (Each Die)	$R_{\theta JC}$	—	—	1.9	$^\circ\text{C/W}$
Thermal Resistance — Free-Wheeling Diode (Each Die)	$R_{\theta JC}$	—	—	3.7	$^\circ\text{C/W}$

(2) 1.0 ms = 1.0% duty cycle

**ELECTRICAL CHARACTERISTICS (continued)** ( $T_J = 25^\circ\text{C}$  unless otherwise noted)

Characteristic	Symbol	Min	Typ	Max	Unit
<b>BRAKE CIRCUIT</b>					
Gate-Emitter Leakage Current ( $V_{CE} = 0\text{ V}$ , $V_{GE} = \pm 20\text{ V}$ )	$I_{GES}$	—	—	$\pm 20$	$\mu\text{A}$
Collector-Emitter Leakage Current ( $V_{CE} = 600\text{ V}$ , $V_{GE} = 0\text{ V}$ ) (1) $T_J = 25^\circ\text{C}$ $T_J = 125^\circ\text{C}$	$I_{CES}$	— —	— —	200 2.0	$\mu\text{A}$ $\text{mA}$
Gate-Emitter Threshold Voltage ( $V_{CE} = V_{GE}$ , $I_C = 1.0\text{ mA}$ )	$V_{GE(th)}$	4.0	6.0	8.0	V
Collector-Emitter Breakdown Voltage ( $I_C = 10\text{ mA}$ , $V_{GE} = 0$ )	$V_{(BR)CES}$	600	700	—	V
Collector-Emitter Saturation Voltage ( $V_{GE} = 15\text{ V}$ , $I_C = 15\text{ A}$ ) (1)	$V_{CE(SAT)}$	—	2.7	3.5	V
Input Capacitance ( $V_{GE} = 0\text{ V}$ , $V_{CE} = 10\text{ V}$ , $f = 1.0\text{ MHz}$ )	$C_{ies}$	—	950	—	pF
Input Gate Charge ( $V_{CE} = 300\text{ V}$ , $I_C = 15\text{ A}$ , $V_{GE} = 15\text{ V}$ )	$Q_T$	—	75	—	nC
Fall Time — Inductive Load ( $V_{CE} = 300\text{ V}$ , $I_C = 15\text{ A}$ , $V_{GE} = 15\text{ V}$ , $R_G = 150\ \Omega$ )	$t_{fi}$	—	200	350	ns
Turn-On Energy ( $V_{CE} = 300\text{ V}$ , $I_C = 15\text{ A}$ , $V_{GE} = 15\text{ V}$ , $R_G = 150\ \Omega$ )	$E_{(on)}$	—	—	1.0	mJ
Turn-Off Energy ( $V_{CE} = 300\text{ V}$ , $I_C = 15\text{ A}$ , $V_{GE} = 15\text{ V}$ , $R_G = 150\ \Omega$ )	$E_{(off)}$	—	—	1.0	mJ
Diode Forward Voltage ( $I_F = 15\text{ A}$ )	$V_F$	—	1.5	2.0	V
Diode Reverse Leakage Current	$I_R$	—	—	50	$\mu\text{A}$
Thermal Resistance — IGBT	$R_{\theta JC}$	—	—	1.9	$^\circ\text{C/W}$
Thermal Resistance — Diode	$R_{\theta JC}$	—	—	3.7	$^\circ\text{C/W}$
<b>SENSE RESISTOR</b>					
Resistance	$R_{sense}$	—	10	—	$\text{m}\Omega$
Resistance Tolerance	$R_{tol}$	-1.0	—	+1.0	%
<b>TEMPERATURE SENSE DIODE</b>					
Forward Voltage (@ $I_F = 1.0\text{ mA}$ )	$V_F$	—	0.660	—	V
Forward Voltage Temperature Coefficient (@ $I_F = 1.0\text{ mA}$ )	$TC_{VF}$	—	-1.95	—	$\text{mV}/^\circ\text{C}$

(1) 1 cycle = 50 or 60 Hz.

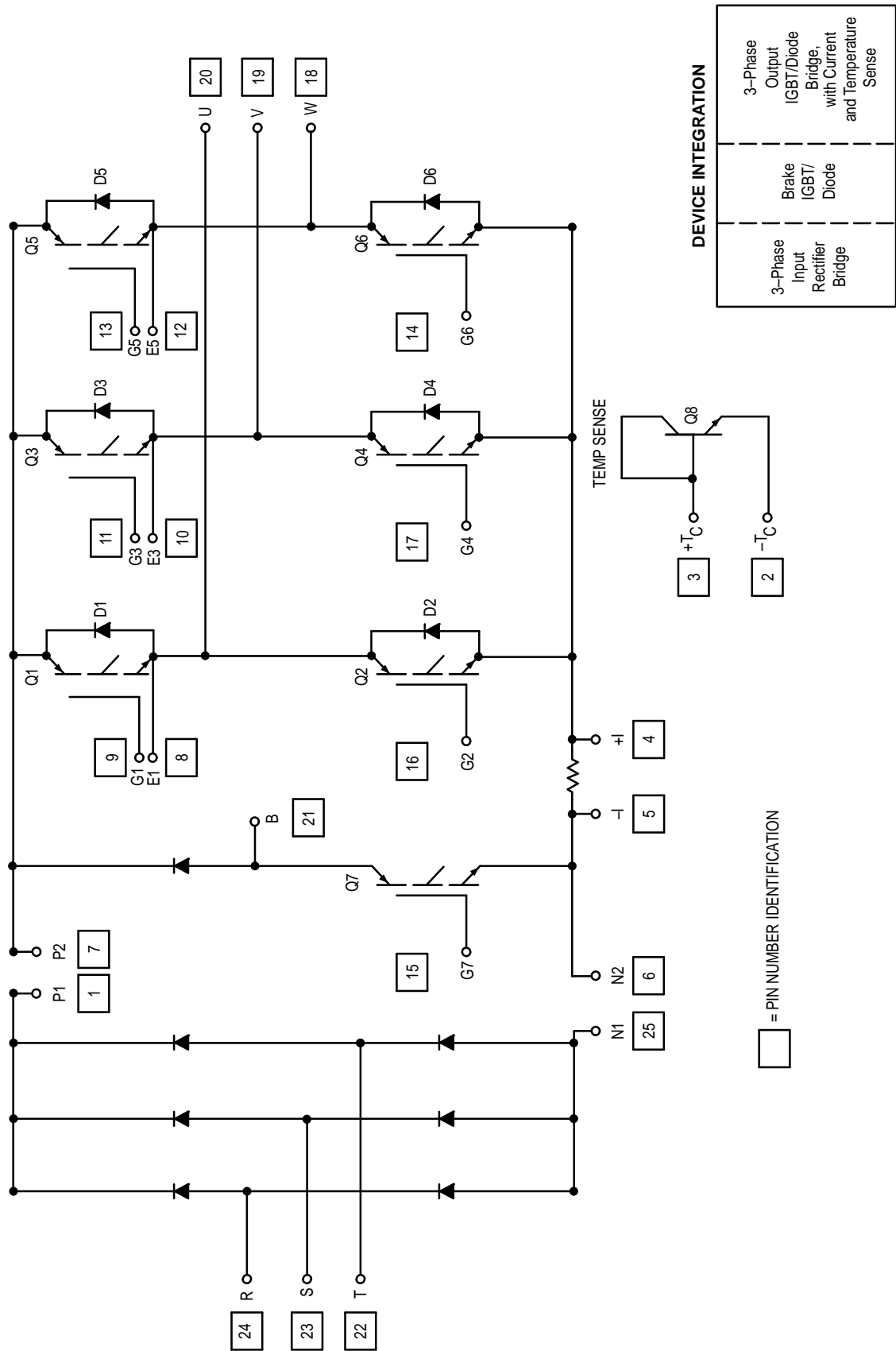


Figure 1. Integrated Power Stage Schematic

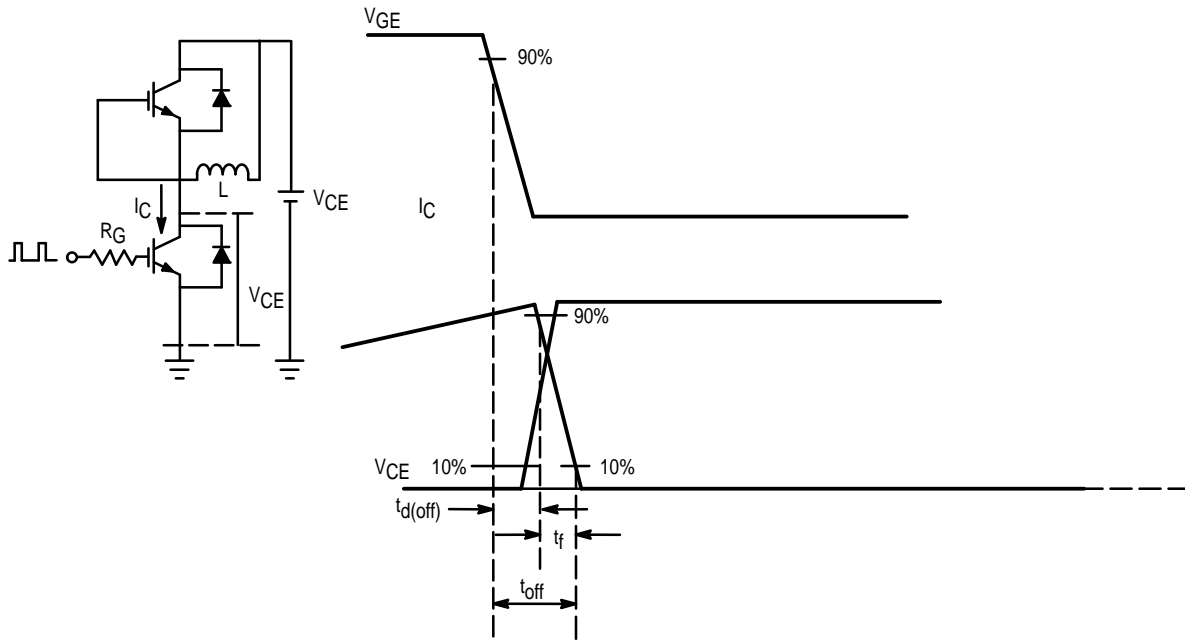


Figure 2. Inductive Switching Time Test Circuit and Timing Chart

### Typical Characteristics

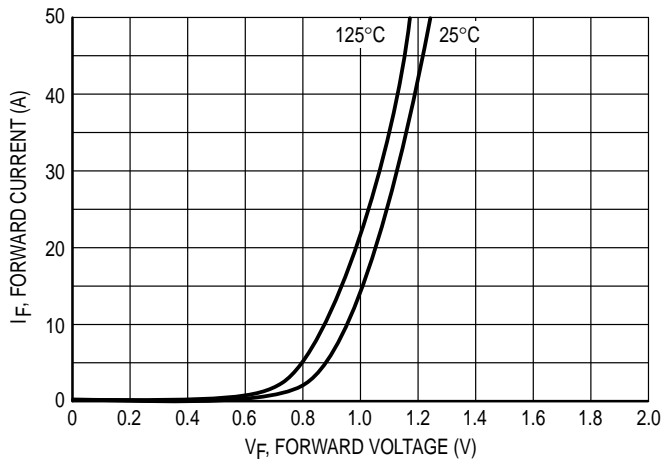


Figure 3. Input Bridge Forward Current versus Forward Voltage

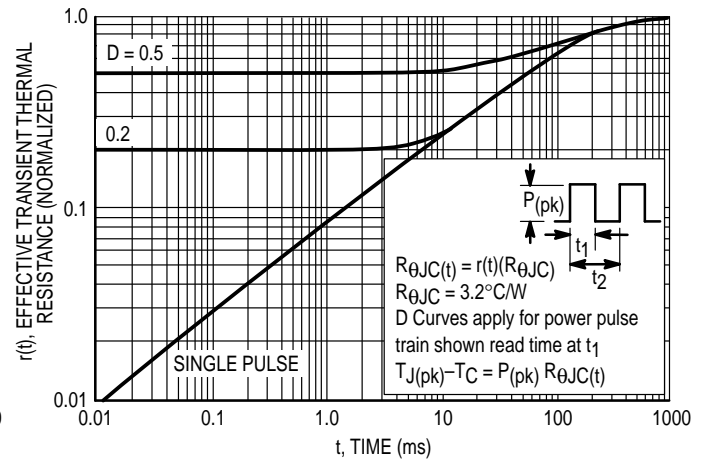
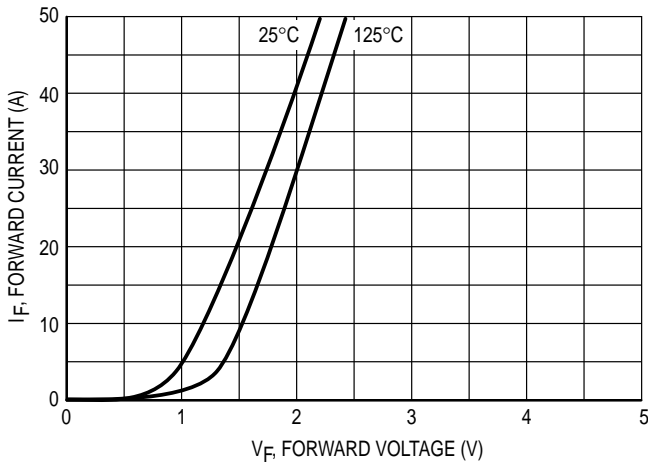
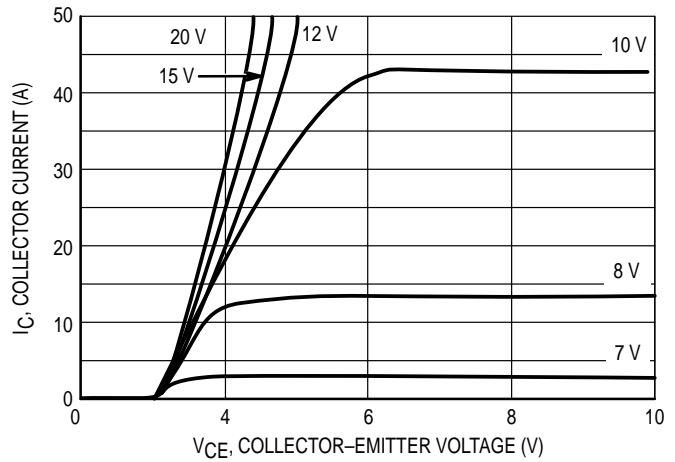


Figure 4. Input Rectifier Bridge Thermal Response

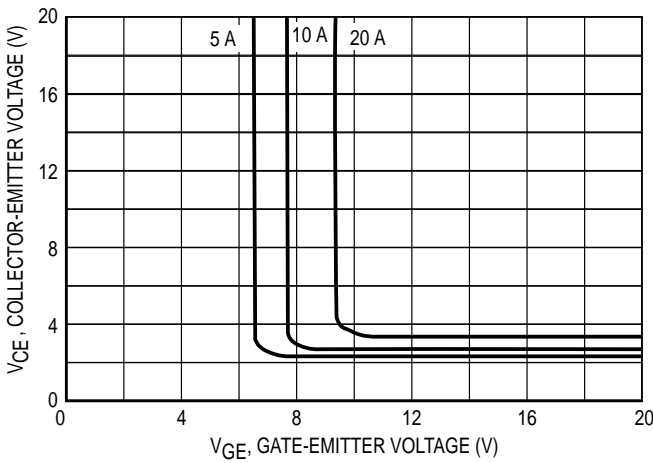
## Typical Characteristics



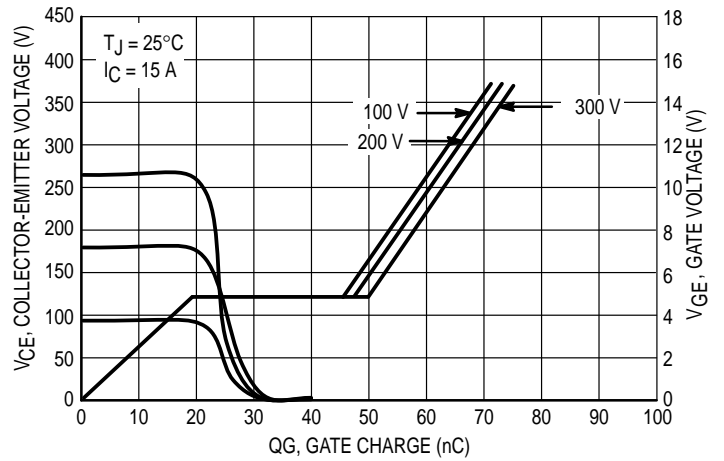
**Figure 5. Output Inverter Diode Forward Current versus Forward Voltage**



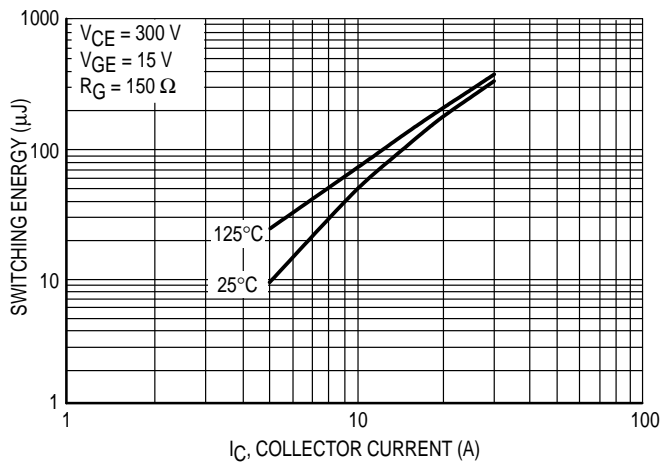
**Figure 6. Output Inverter Collector-Current versus Collector-Emitter Voltage**



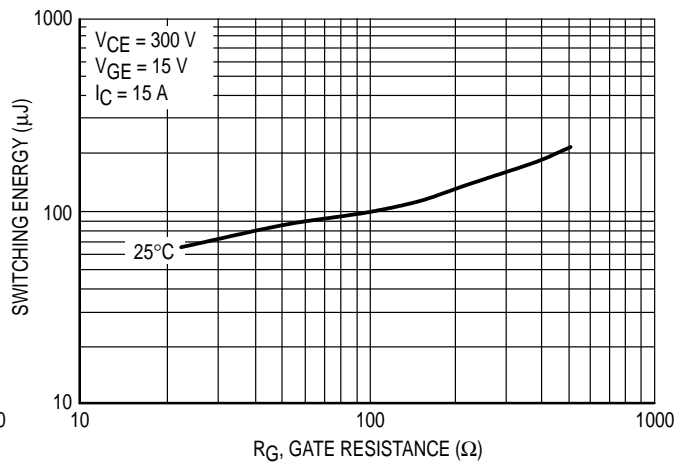
**Figure 7. Output Inverter Collector-Emitter Voltage versus Gate-Emitter Voltage**



**Figure 8. Gate-to-Emitter Voltage versus Gate Charge**

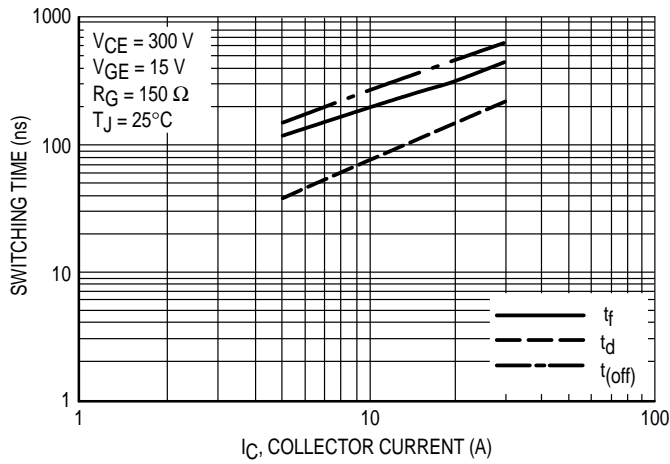


**Figure 9. Inverter Switching Energy  $E_{(off)}$  versus Collector Current  $I_C$**

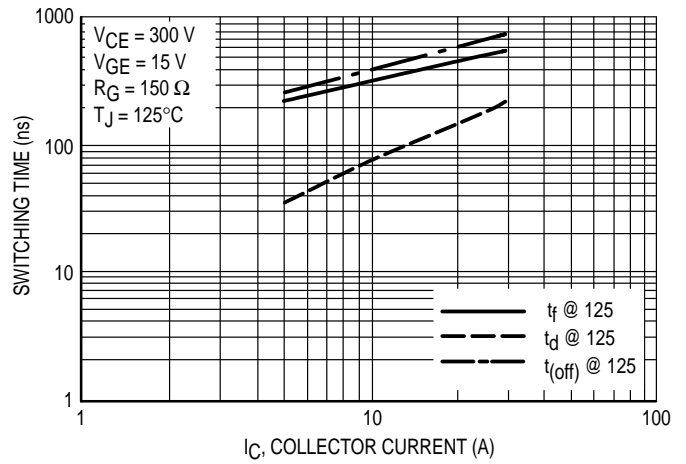


**Figure 10. Inverter Switching Energy  $E_{(off)}$  versus Gate Resistance  $R_G$**

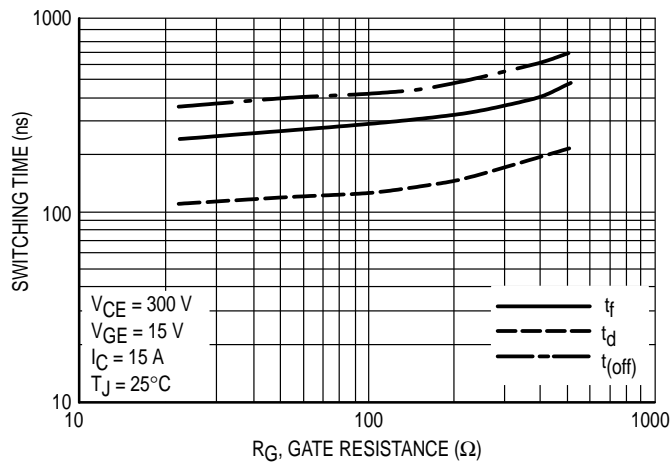
## Typical Characteristics



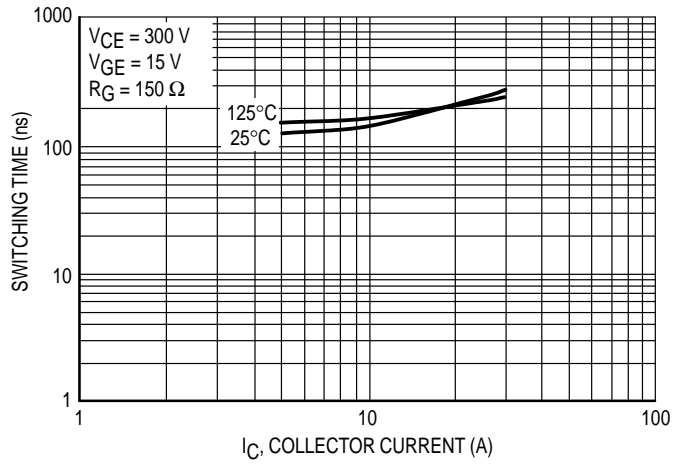
**Figure 11. Inverter Switching Time  $t_f$ ,  $t_d$ ,  $t_{(off)}$  versus Collector Current  $I_C$**



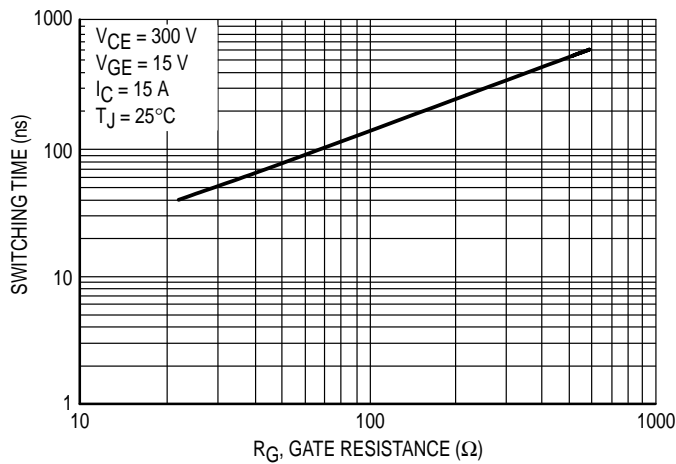
**Figure 12. Inverter Switching Time  $t_f$ ,  $t_d$ ,  $t_{(off)}$  versus Collector Current  $I_C$**



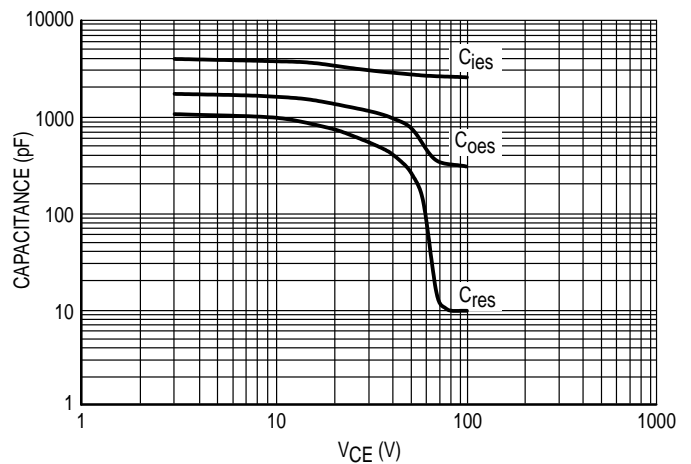
**Figure 13. Inverter Switching Time  $t_f$ ,  $t_d$ ,  $t_{(off)}$  versus Gate Resistance  $R_G$**



**Figure 14. Inverter Switching Time  $t_f$  versus Collector Current  $I_C$**

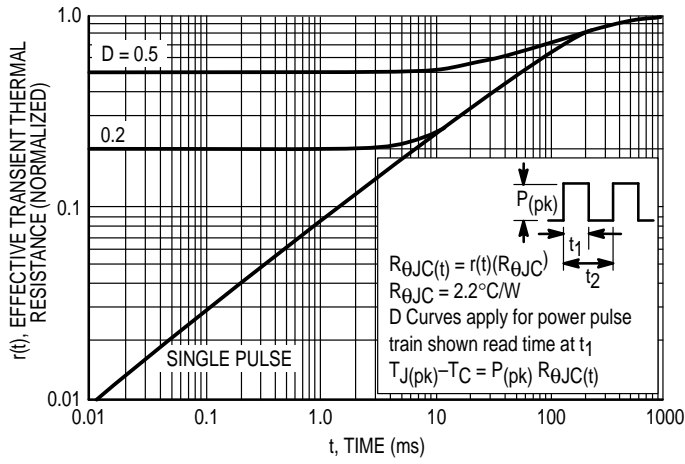


**Figure 15. Inverter Switching Time  $t_f$  versus Gate Resistance  $R_G$**

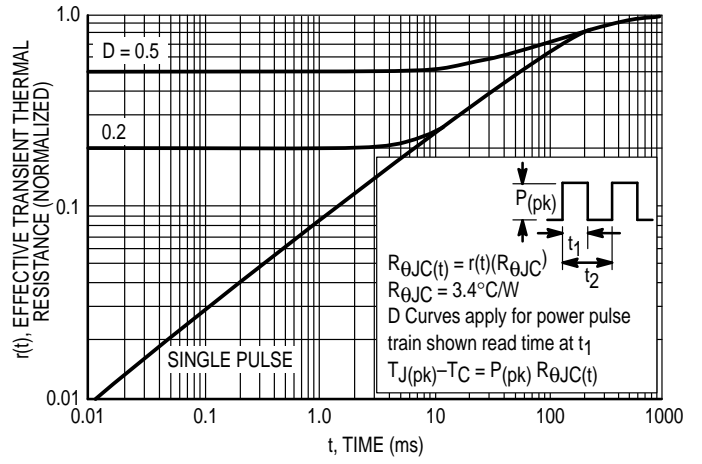


**Figure 16. Inverter Capacitance versus  $V_{CE}$**

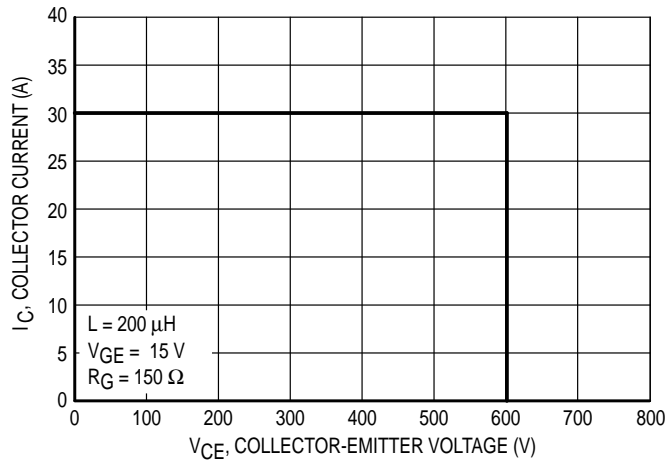
## Typical Characteristics



**Figure 17. Output Inverter IGBT Thermal Response**



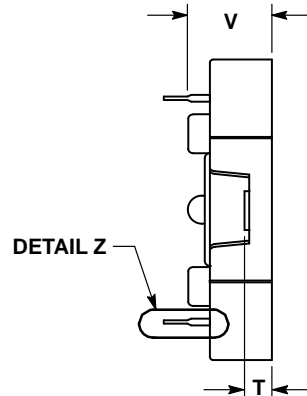
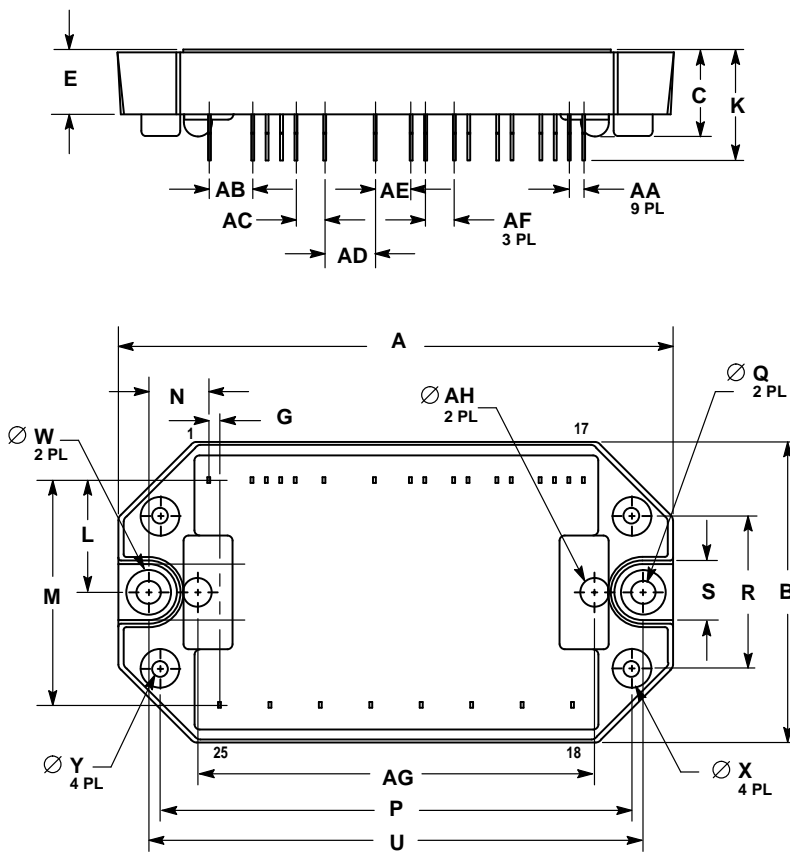
**Figure 18. Output Diode Thermal Response**



**Figure 19. Output Inverter Reverse Bias Safe Operating Area (RBSOA)**

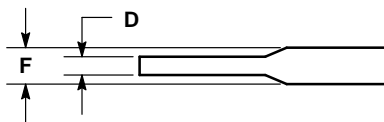
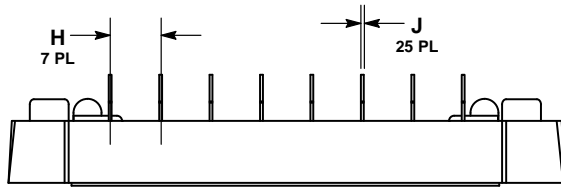


# PACKAGE DIMENSIONS



- NOTES:
1. DIMENSIONING AND TOLERANCING PER ANSI Y14.5M, 1982.
  2. CONTROLLING DIMENSION: MILLIMETER.
  3. LEAD LOCATION DIMENSIONS (ie: M, B, AA...) ARE TO THE CENTER OF THE LEAD.


DIM	MILLIMETERS		INCHES	
	MIN	MAX	MIN	MAX
A	97.54	98.55	3.840	3.880
B	52.45	53.47	2.065	2.105
C	14.60	15.88	0.575	0.625
D	0.43	0.84	0.017	0.033
E	10.80	12.06	0.425	0.475
F	0.94	1.35	0.037	0.053
G	1.60	2.21	0.063	0.087
H	8.58	9.19	0.338	0.362
J	0.30	0.71	0.012	0.028
K	18.80	20.57	0.74	0.81
L	19.30	20.32	0.760	0.800
M	38.99	40.26	1.535	1.585
N	9.78	11.05	0.385	0.435
P	82.55	83.57	3.250	3.290
Q	4.01	4.62	0.158	0.182
R	26.42	27.43	1.040	1.080
S	12.06	12.95	0.475	0.515
T	4.32	5.33	0.170	0.210
U	86.36	87.38	3.400	3.440
V	14.22	15.24	0.560	0.600
W	7.62	8.13	0.300	0.320
X	6.55	7.16	0.258	0.282
Y	2.49	3.10	0.098	0.122
AA	2.24	2.84	0.088	0.112
AB	7.32	7.92	0.288	0.312
AC	4.78	5.38	0.188	0.212
AD	8.58	9.19	0.338	0.362
AE	6.05	6.65	0.238	0.262
AF	4.78	5.38	0.188	0.212
AG	69.34	70.36	2.730	2.770
AH	—	5.08	—	0.200



DETAIL Z

- STYLE 1:
- |           |           |            |            |           |
|-----------|-----------|------------|------------|-----------|
| PIN 1. P1 | PIN 6. N2 | PIN 11. G3 | PIN 16. G2 | PIN 21. B |
| 2. T-     | 7. P2     | 12. K5     | 17. G4     | 22. T     |
| 3. T+     | 8. K1     | 13. G5     | 18. W      | 23. S     |
| 4. I+     | 9. G1     | 14. G6     | 19. V      | 24. R     |
| 5. I-     | 10. K3    | 15. G7     | 20. U      | 25. N1    |

CASE 440-01  
ISSUE O

Motorola reserves the right to make changes without further notice to any products herein. Motorola makes no warranty, representation or guarantee regarding the suitability of its products for any particular purpose, nor does Motorola assume any liability arising out of the application or use of any product or circuit, and specifically disclaims any and all liability, including without limitation consequential or incidental damages. "Typical" parameters can and do vary in different applications. All operating parameters, including "Typicals" must be validated for each customer application by customer's technical experts. Motorola does not convey any license under its patent rights nor the rights of others. Motorola products are not designed, intended, or authorized for use as components in systems intended for surgical implant into the body, or other applications intended to support or sustain life, or for any other application in which the failure of the Motorola product could create a situation where personal injury or death may occur. Should Buyer purchase or use Motorola products for any such unintended or unauthorized application, Buyer shall indemnify and hold Motorola and its officers, employees, subsidiaries, affiliates, and distributors harmless against all claims, costs, damages, and expenses, and reasonable attorney fees arising out of, directly or indirectly, any claim of personal injury or death associated with such unintended or unauthorized use, even if such claim alleges that Motorola was negligent regarding the design or manufacture of the part. Motorola and  are registered trademarks of Motorola, Inc. Motorola, Inc. is an Equal Opportunity/Affirmative Action Employer.

**How to reach us:**

**USA / EUROPE:** Motorola Literature Distribution;  
P.O. Box 20912; Phoenix, Arizona 85036. 1-800-441-2447

**JAPAN:** Nippon Motorola Ltd.; Tatsumi-SPD-JLDC, Toshikatsu Otsuki,  
6F Seibu-Butsuryu-Center, 3-14-2 Tatsumi Koto-Ku, Tokyo 135, Japan. 03-3521-8315

**MFAX:** RMFAX0@email.sps.mot.com - TOUCHTONE (602) 244-6609  
**INTERNET:** <http://Design-NET.com>

**HONG KONG:** Motorola Semiconductors H.K. Ltd.; 8B Tai Ping Industrial Park,  
51 Ting Kok Road, Tai Po, N.T., Hong Kong. 852-26629298



**MOTOROLA**



This datasheet has been download from:

[www.datasheetcatalog.com](http://www.datasheetcatalog.com)

Datasheets for electronics components.