

IGBT MODULE (F series)

■ Features

- Low Saturation Voltage
- Voltage Drive
- Variety of Power Capacity Series

■ Applications

- Inverter for Motor Drive
- AC and DC Servo Drive Amplifier
- Uninterruptible Power Supply
- Industrial Machines, such as Welding Machines

■ Maximum Ratings and Characteristics

● Absolute Maximum Ratings

| Items | Symbols | Ratings | Units |
|---------------------------|------------------|-----------------------|-----------|
| Collector-Emitter Voltage | V _{CEs} | 600 | V |
| Gate-Emitter Voltage | V _{GES} | ±20 | V |
| Collector Current | Continuous | I _c | 50 |
| | 1ms | I _{c pulse} | 100 |
| | Continuous | -I _c | 50 |
| | 1ms | -I _{c pulse} | 100 |
| Max. Power Dissipation | P _c | 220 | W |
| Operating Temperature | T _j | +150 | °C |
| Storage Temperature | T _{stg} | -40 to +125 | °C |
| Net. Weight | | 510 | g |
| Isolation Voltage | AC. 1min. | V _{isol} | 2500 |
| Screw Torque | Mounting *1 | 3.5 {35} | N · m |
| | Terminals *2 | 1.7 {17} | {kg · cm} |

*1 Recommendable Value 2.5 to 3.5 N·m {25 to 35 kg·cm} (M5)

*2 Recommendable Value 1.3 to 1.7 N·m {13 to 17 kg·cm} (M4)

● Electrical Characteristics (T_c=25°C)

| Items | Symbols | Test Conditions | Min. | Typ. | Max. | Units |
|--------------------------------------|----------------------|---|------|------|------|-------|
| Zero Gate Voltage Collector Current | I _{CEs} | V _{GE} =0V V _{CE} =600V T _j =25°C | | | 1.0 | mA |
| | | V _{GE} =0V V _{CE} =600V T _j =125°C | | | — | mA |
| Gate-Emitter Leakage Current | I _{GES} | V _{CE} =0V V _{GE} =±20V | | | 100 | nA |
| Gate-Emitter Threshold Voltage | V _{GE(th)} | V _{CE} =20V I _c =50mA | 3.0 | | 6.0 | V |
| Collector-Emitter Saturation Voltage | V _{CE(sat)} | V _{GE} =15V I _c =50A | | | 2.5 | V |
| Input Capacitance | C _{ies} | V _{GE} =0V | | 4750 | | pF |
| Output Capacitance | C _{oes} | V _{CE} =10V | | | | |
| Reverse Transfer Capacitance | C _{res} | f=1MHz | | | | |
| Turn-on Time | t _{on} | V _{CC} =300V | | | 0.8 | μs |
| | t _r | I _c =50A | | | 0.6 | |
| Turn-off Time | t _{off} | V _{GE} =±15V | | | 1.5 | |
| | t _f | R _G =51Ω | | | 1.0 | |
| Diode Forward On-Voltage | V _F | I _F =50A, V _{GE} =0V | | | 2.5 | V |
| Reverse Recovery Time | t _{rr} | I _F =50A, -di/dt=150A/μs V _{GE} =-10V | | | 300 | ns |

● Thermal Characteristics

| Items | Symbols | Test Conditions | Min. | Typ. | Max. | Units |
|--------------------|----------------------|-----------------------|------|------|-------|-------|
| Thermal Resistance | R _{th(j-c)} | IGBT | | | 0.568 | °C/W |
| | R _{th(j-c)} | Diode | | | 1.33 | |
| | R _{th(c-f)} | With Thermal compound | | 0.05 | | |

■ Outline Drawings

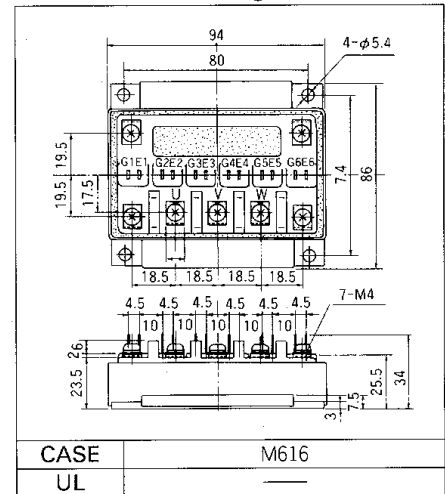

■ Equivalent Circuit Schematic

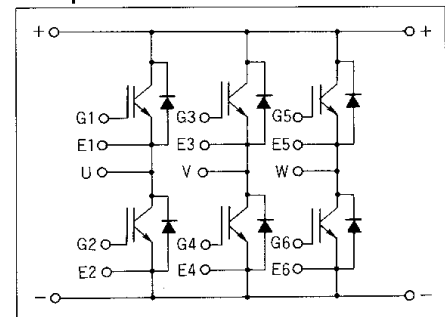

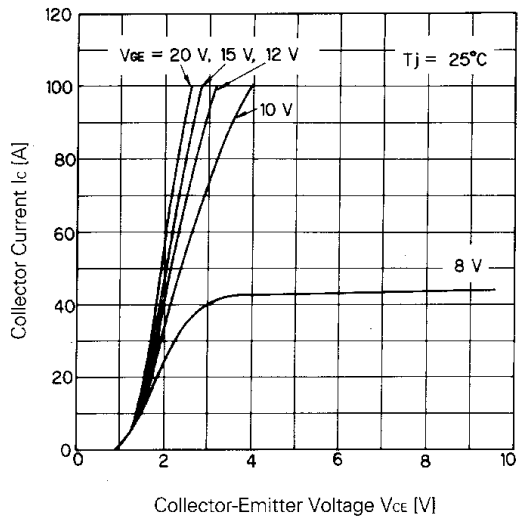

Collector Current vs. Collector-Emitter Voltage

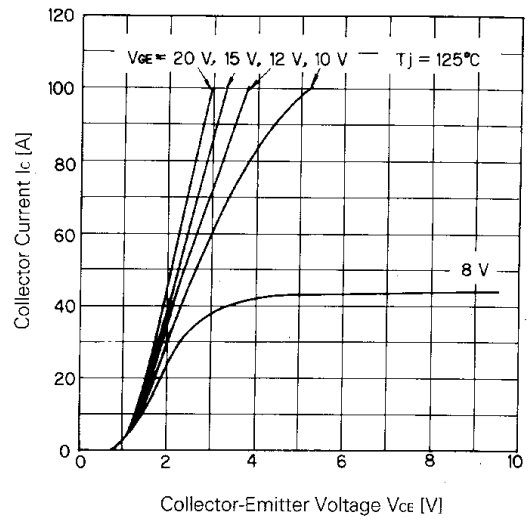

Collector Current vs. Collector-Emitter Voltage

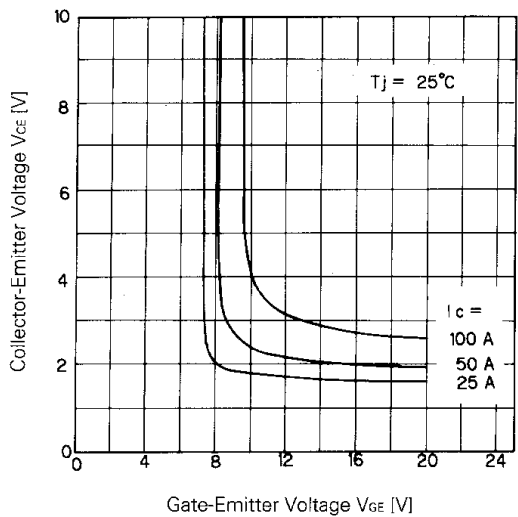

Collector-Emitter Voltage vs. Gate-Emitter Voltage

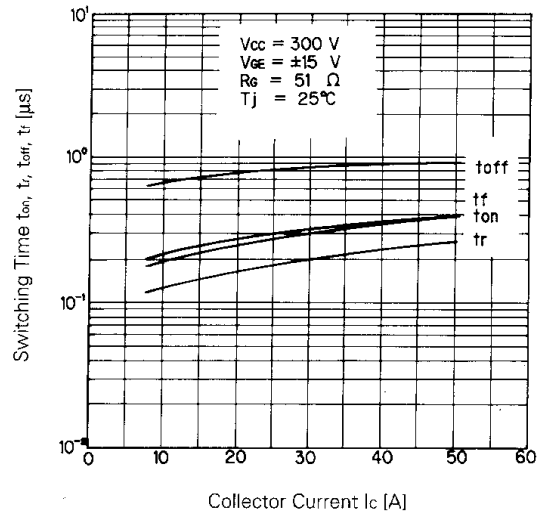

Switching Time

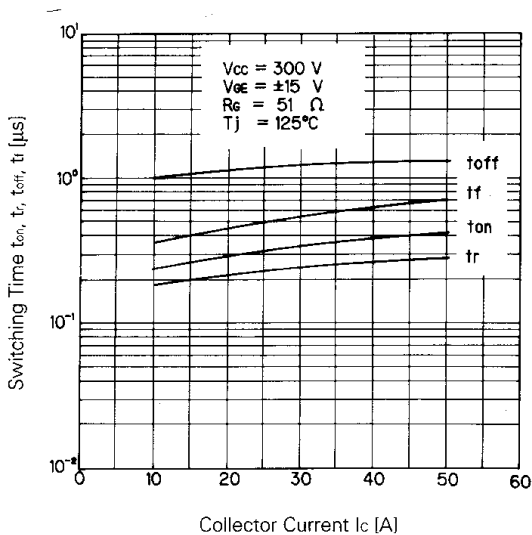

Switching Time

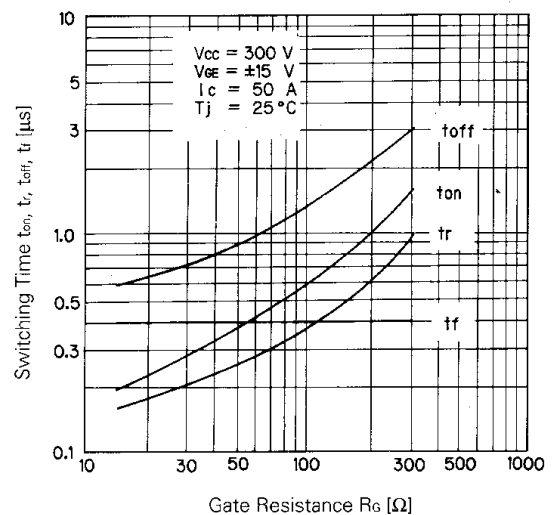

Switching Time-Gate Resistance

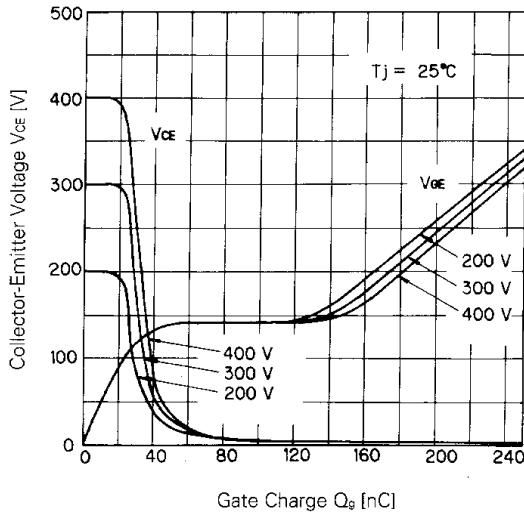

Dynamic Input Characteristic

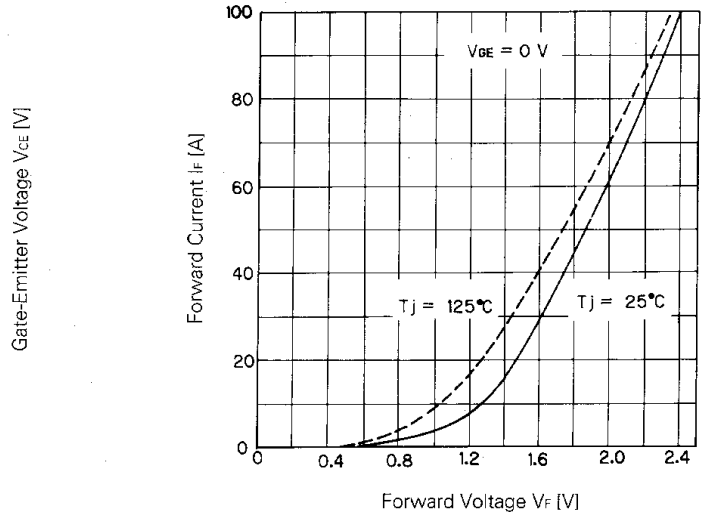

Forward Voltage of Free Wheel Diode

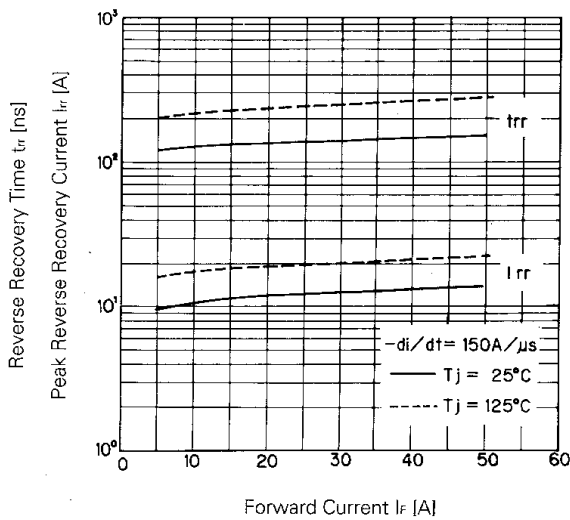

$T_{rr}, I_{rr}-I_f$

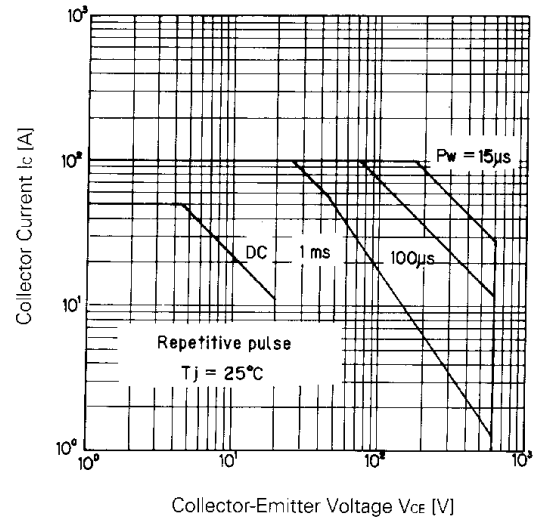

Safe Operating Area

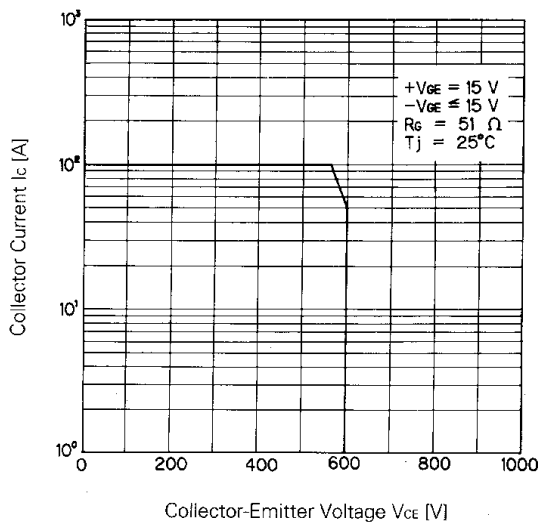

Reverse Biased Safe Operating Area

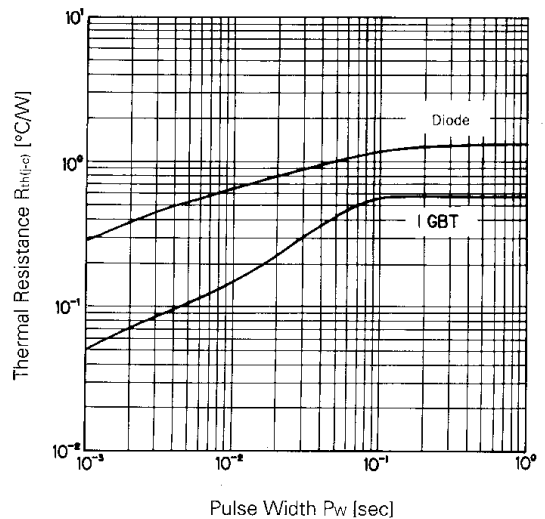

Transient Thermal Resistance

For more information, contact:

Collmer Semiconductor, Inc.

P.O. Box 702708

Dallas, TX 75370

972-733-1700

972-381-9991 Fax

<http://www.collmer.com>